

 DIN Rail Terminals

 Bornes de Jonction pour Rails DIN

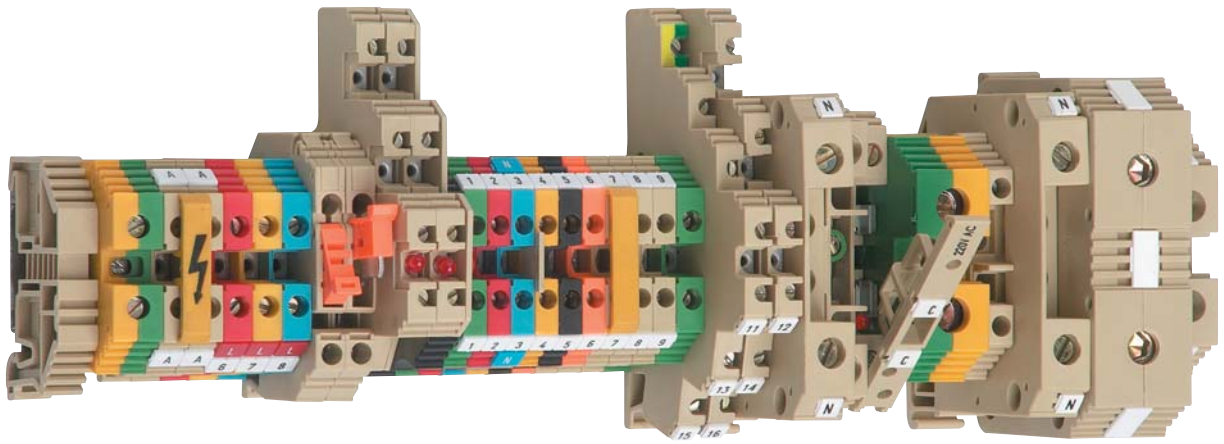

Keep on the **right track**



IMO has been manufacturing innovative control components since 1970. The continuous expansion of the company's manufacturing resources and the development of strategic alliances with manufacturing centres of excellence have produced one of the finest ranges of automation and controls products available today. The first company in Europe to do so, IMO gives a no-quibble Three Year Warranty on the majority of its electronics based control components and a Five Year Warranty on the full range of Jaguar Drives.



IMO produce dispositivi di controllo innovativi sin dal 1970. La continua espansione produttiva della società e delle sue risorse e lo sviluppo d'alleanze strategiche con centri di produzione d'eccellenza, hanno creato una delle migliori gamme di prodotti per l'automazione e controllo oggi disponibile.

La prima azienda in Europa a farlo, IMO offre una garanzia di tre anni senza condizioni sulla maggior parte dei suoi componenti di controllo elettronico ed una garanzia di cinque anni su tutta la gamma d'Inverter IMO Jaguar.



IMO stellt seit 1970 innovative Steuerungsbestandteile her. Die ununterbrochene Erweiterung der Herstellung und Ressourcen des Unternehmens und die Entwicklung von strategischen Allianzen mit vortrefflichen Herstellungszentren haben zu einer der besten Reihen von Automatisierungs- und Steuerungsprodukten, die heutzutage erhältlich sind, geführt. IMO ist das erste Unternehmen in Europa, das eine bedingungslose Drei-Jahres-Garantie auf die Mehrzahl seiner elektronisch-basierten Steuerungsbestandteile, und eine Fünf-Jahres-Garantie auf die komplette Reihe der Jaguar Antriebe anbietet.



Depuis 1970, IMO a développé des solutions innovantes pour le contrôle de processus et de production.

L'accroissement continu de ses ressources de fabrication, allié à un développement d'alliances stratégiques avec des centres de fabrication de haute qualité a permis à la société IMO de disposer de produits d'automatisme et de contrôle parmi les meilleurs actuellement. Première société en Europe à le proposer, IMO offre une garantie sans discuter de trois ans sur la majorité de ses produits d'automatisme et de contrôle équipés d'électronique et de cinq ans sur l'ensemble de sa gamme de variateurs de vitesse Jaguar.



IMO se encuentra en la vanguardia de los dispositivos de control y automatización desde 1970. La continua expansión de sus centros de producción y el desarrollo de estratégicas alianzas en la fabricación, nos permiten ofrecer una de las líneas de producto en dispositivos de automatización y control, más atractiva y completa del mercado actual.

Siendo la primera compañía europea en utilizar estas dinámicas de comercialización, IMO cubre la mayoría de sus productos de control electrónico, con una garantía "sin objeciones" de tres años, que se convierten en cinco años para el caso de todos los variadores de velocidad serie Jaguar.

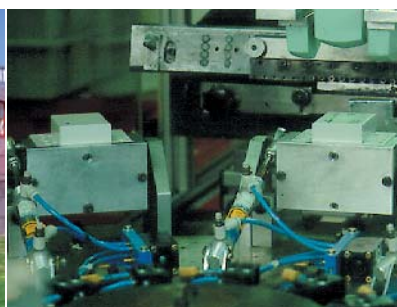

Contents

T15 Series	14
ER Series	16
ER 4C Series	18
ERPE Series	19
ERB Series	20
ERD 2.5 Series	22
ERD 4 Series	24
ERT Series	26
ERT 3S Series	28
ERTD Series	30
ERF Series	32
ERF4 Series	34
ERWT Series	36
ERDT Series	37
SC Series	38
SCS Series	40
SCD Series	42
SCPE Series	44
SCD 2.5 Series	46
SCD 4 Series	48
SCF Series	50
SCT Series	52
SCT3 Series	54
PM Series	56
Terminal Strips / Busbars	58
Clamping Yokes	59
Marking Tags	60
Product Index	61



Flexible Solutions for Customer Applications...

IMO are able to offer pre-assembled rail assemblies built to customer specification.

IMO Assembly Division

To satisfy an ever growing trend in the market, IMO have established an Assembly Division to provide solutions to customer requirements for components assembled onto rails, or into enclosures.

IMO are in a position to offer customised solutions which can also include many other control components such as Contactors, Relays, Timers Mcb's etc.

What ever your requirements, from a simple rail to a complex solution, contact IMO for help and assistance.

Des Solutions sur Mesure pour Nos Clients...

IMO propose à ses clients des rails de modules préassemblés selon leurs spécifications

Division Assemblage Chez IMO

Pour satisfaire à une demande du marché, IMO a développé une division assemblage afin de pouvoir proposer des solutions spécifiques de rails préassemblés ou de coffrets.

IMO peut, bien sûr, y inclure beaucoup d'autres composants tels que : contacteurs, relais, temporisateurs, disjoncteurs etc.

Quelque soit votre besoin du simple rail à une solution complexe n'hésitez pas à contacter IMO pour aide ou assistance.

4



...Worldwide

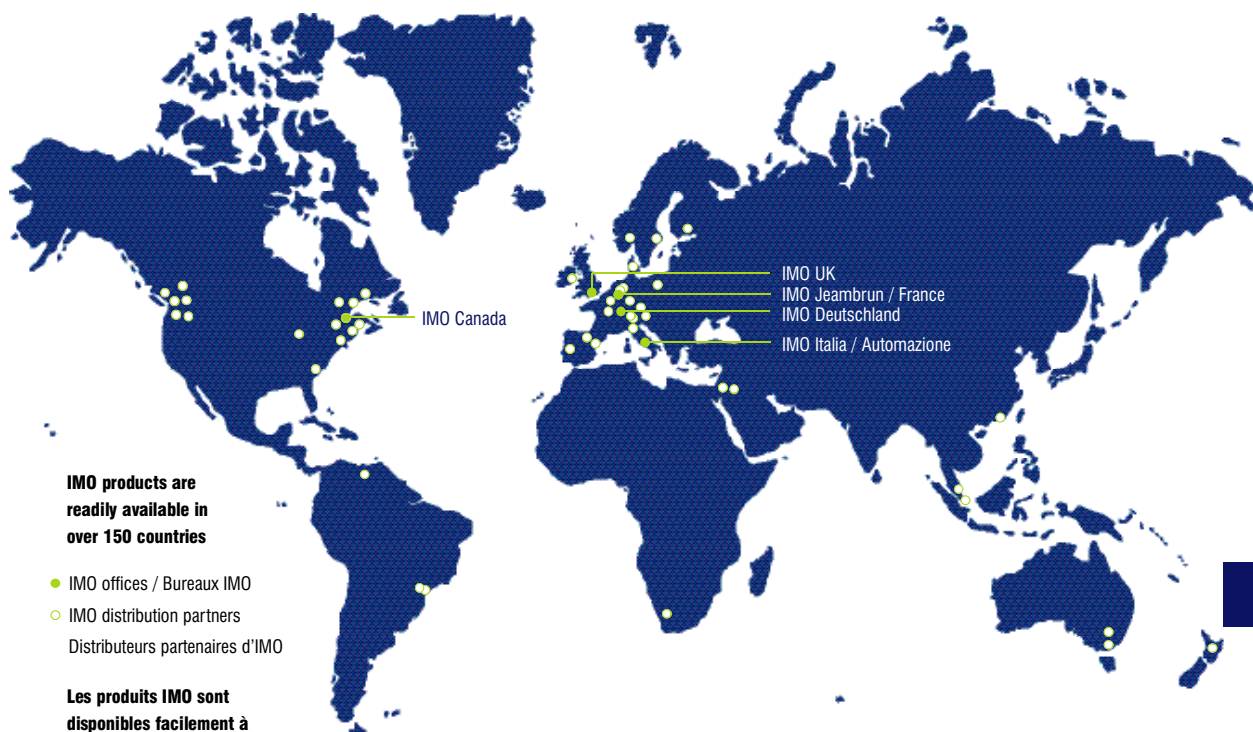

IMO products are readily available in over 150 countries

- IMO offices / Bureaux IMO
- IMO distribution partners
Distributeurs partenaires d'IMO

Les produits IMO sont disponibles facilement à travers plus de 150 pays

www.imopc.com

With secure ordering, supply line visibility, despatch from multiple stock centres worldwide and even downloadable technical manuals, imopc.com is the 24/7 solution for quality automation and control components.

www.imopc.fr

Avec un système de commande sécurisée, une visibilité pour chaque ligne de commande, une livraison à partir de multiples centres de stockage et même un téléchargement des manuels techniques imopc.com est votre solution 24 heures sur 24, 7 jours sur 7 pour l'approvisionnement de composants d'automation et de contrôle de qualité.



ER2.5-T15

ER4-T15

ERPE 2.5-T15

ERPE 4-T15

ER 2.5

ER 4

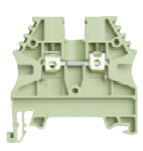
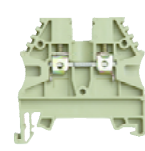
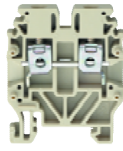
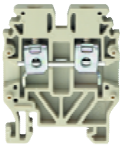

← Mini Terminals / Mini Bornes →

←

ERPE 2.5/4

ERPE 6/10

ERPE 16/35

SC 2.5

SC 4

SC 6

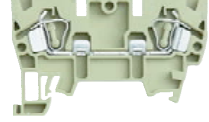
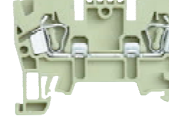
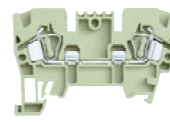
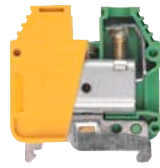

← Earth Terminals / Bornes de terre →

← Spring Clamp Terminals / Bornes à Ressort →

6

SCD 4

SCD 4V

SCD 4D

SCD 4LD

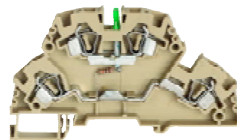
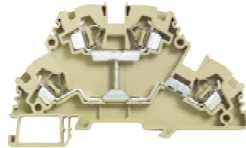

← Double-deck Spring terminals / Bornes à ressort à deux niveaux →

SFTD3

SFTD4

ERB 95

ERB 150

ERB 240

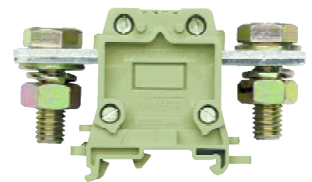
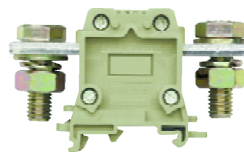
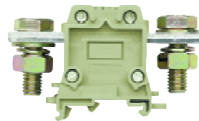
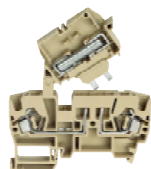
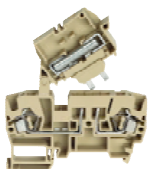

← Busbar Terminals / Bornes boulons →

ER 6

ER 10

ER 16

ER 35

ER70

ER 4C

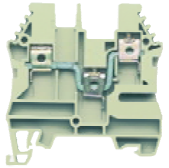
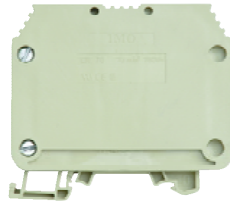
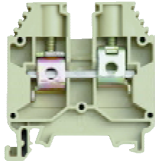
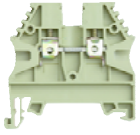
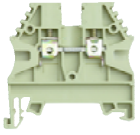

Rail Terminals / Bornes de jonction pour rails

SC 10

SCPE 2.5

SCPE 4

SCPE 6

SCPE 10

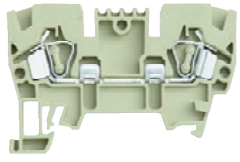

Earth Terminals / Bornes de terre

SC T3

SCT 3E

SCF3

SCF3LD

SCF4

SCF4LD

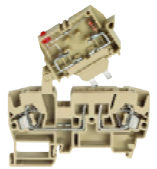
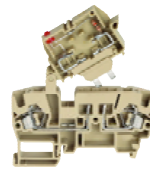

Spring Clamp Terminals for Initiators, Actuators and Motors / Bornes à ressort pour capteurs, actionneurs et moteurs

ERD 2.5

ERD 2.5V

ERD 2.5D

ERD 2.5LD

ERD 2.5LD

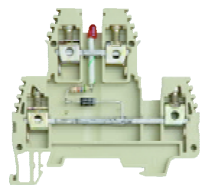
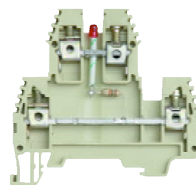
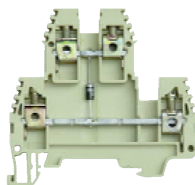
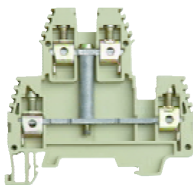
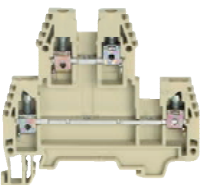

Double level Rail Terminals / Bornes de jonction à doubles niveaux

ERD 4

ERD 4V

ERD 4D

ERD 4LD

ERD 4LD

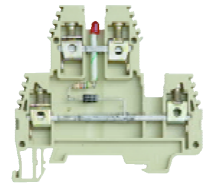
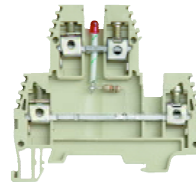
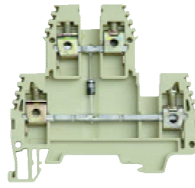
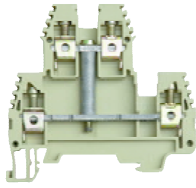
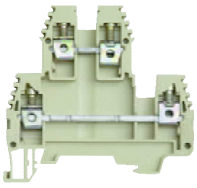

← Double level Rail Terminals / Bornes de jonction à doubles niveaux →

ERT3 S

ERT3 SLD

ERT3 SLD

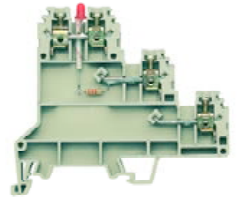
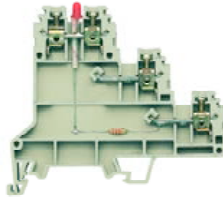
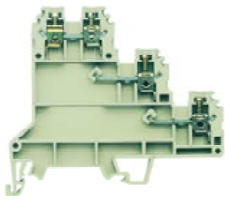

← Three level Sensor Terminals / Bornes de jonction à trois niveaux pour capteurs →

ERTD4

ERTD3

ERTD3M

ERTD2

ERF2

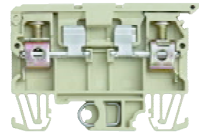
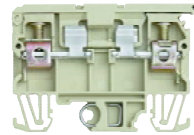
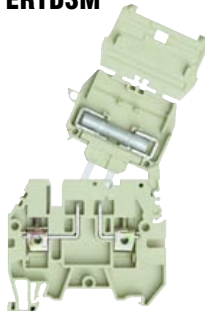
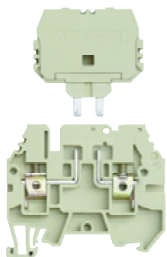
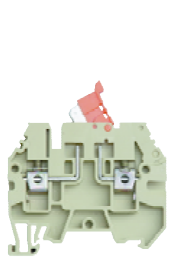

← Disconnect Terminals / Bornes de jonction déconnectables →

ERF4

ERF4 LD

PM2.5

PM4

PM10

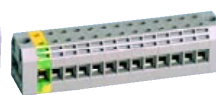
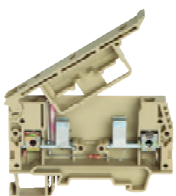
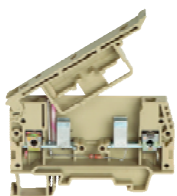

← Fuse & disconnect Terminals / Bornes déconnectables et à fusible →

← Panel Mounting Terminals / Bornes pour montage en armoire →

ER T3

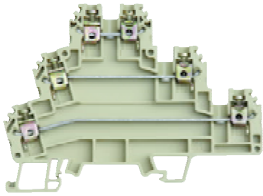

ER T2E

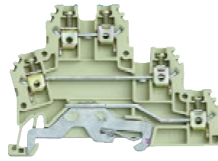

ER T3E

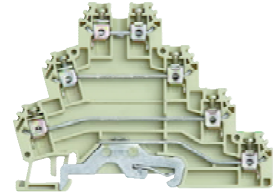

← Feed Through Terminal Blocks For Initiators, Actuators and Motors / Bornes de jonction pour détecteurs, actionneurs et moteurs →

ERDT 10/16

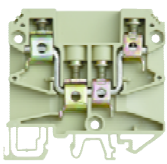

ERDT 10/16 2, 3, 4, 5mm
(With End Plate/Plaquelette d'extrémité)



ERWT1

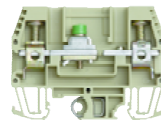

ERWT2

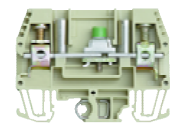

← Distribution Terminals / Bornes de distribution →

← Test and Disconnect Terminals / Bornes de tests et de déconnexion →

ERF2 LD

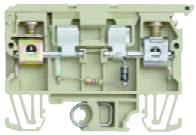

ERF3

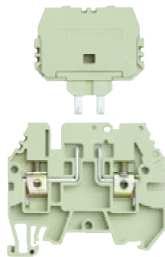

ERF3 FLD

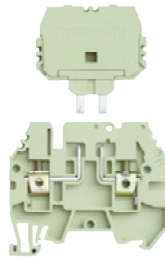

ERF3M

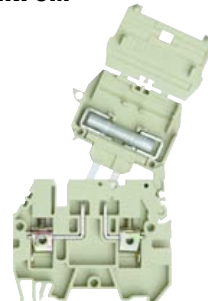

ERF3 MLD

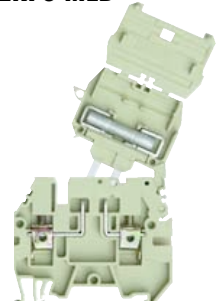

← Fuse Terminals / Bornes de jonction avec fusible →

SCS 2.5

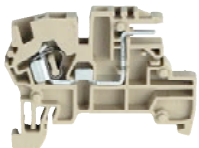

SCS 2.5E

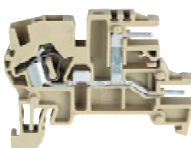

SCS 2.5L



SCS 2.5EL



SCS 2.5N



← Terminals for PCB Connections / Bornes pour Connexion sur Circuits Imprimés →

TS1



TS2

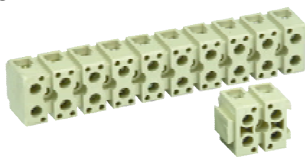

CC

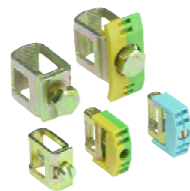

Terminal strips / Barrette de connexion

Clamping yokes / bornes de serrage pour barre

CCSC



CC

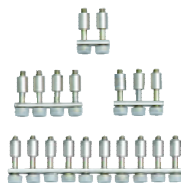

TF



Cross-Connection / Shunt

Test Plug-Soc / Pointe de test

WL

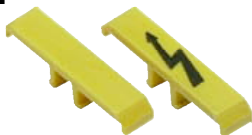

GM



ES



IC

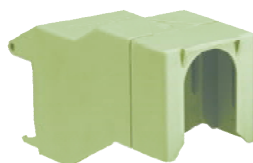

Warning Labels / Plaquette d'alarme

Group Marking / Marquage de groupe

Group Marking / Marquage de groupe

Isolation Cover / Carter d'isolation

10

EP



EP



EP



EP



End Plate / Plaquette d'extrémité

EP



CCB

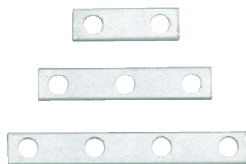

SL



DINBRACKT M5/M6



End Plate / Plaquette d'extrémité

Cross-Connection / Shunt

Switchable Cross-Con / Interconnexion commutable

Bracket / Console

GM



BSBI



**MODI-KIT
KIT-BORNE**



- Contains most popular terminals
- Accessories to suit
- Terminal markers and pen
- Ideal for panel modification
- Ideal for design, R & D etc
- Contient la plupart des bornes standard
- Accessoires appropriés
- Repérage des bornes et stylo
- Idéal pour la modification du panneau
- Idéal pour la conception, la recherche et le développement

Group Marking / Marquage de groupe

Busbar Support Block / Bloc support pour barre

DIN rail terminals Modi-Kit
Kit de blocs de jonction standard pour rails DIN

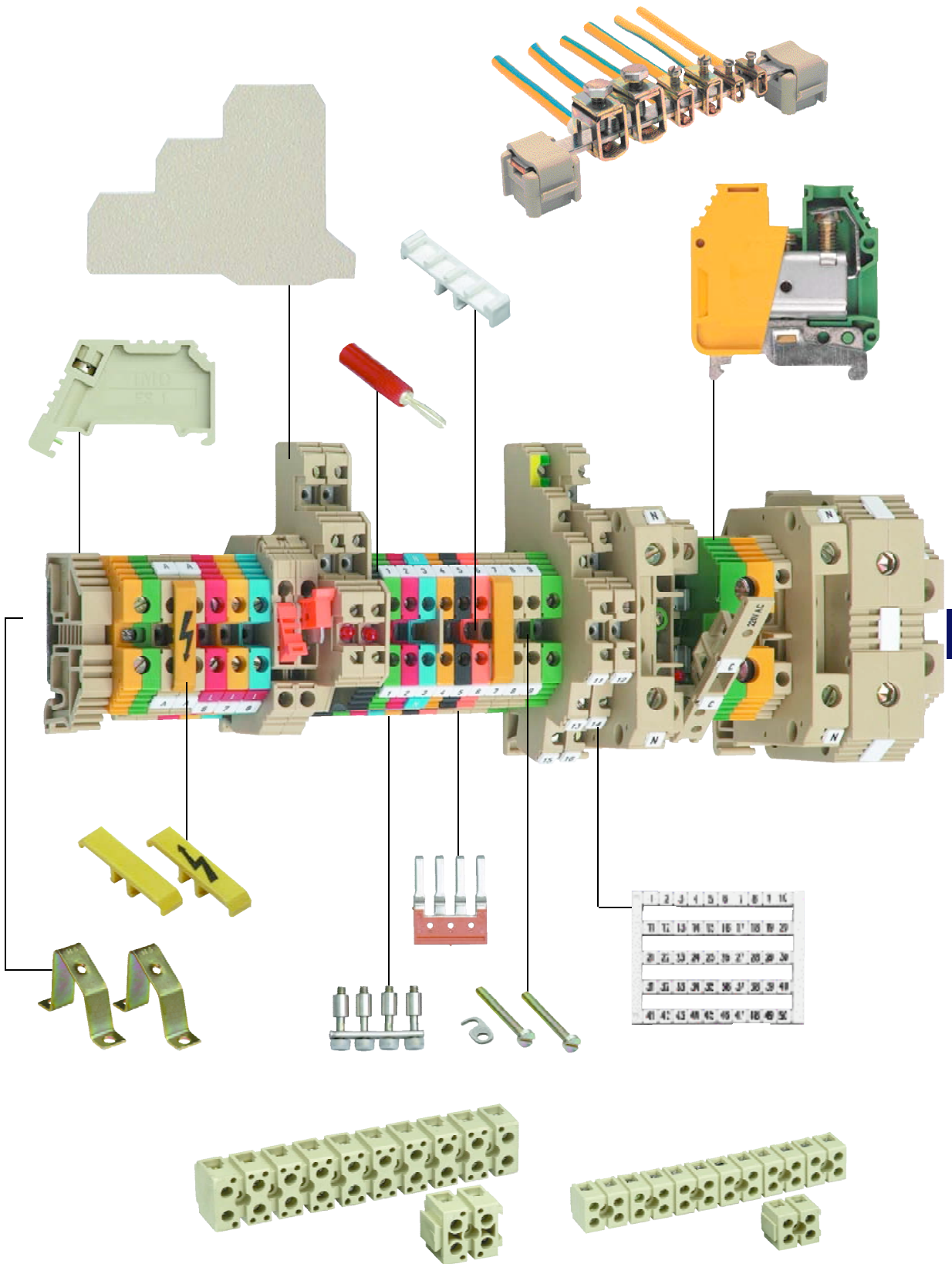

Terminal blocks

Bornes de jonction

Terminal blocks are components and systems the main function of which is to ensure safe and secure electrical and mechanical conductor connections. The term covers all conceivable types, designs and forms of connection. From the point of view of application, the most important group of terminals is that of rail mounted modular terminal blocks.

- The current carrying bar must be made of metals which reduce electrical losses to minimum.
- Insulation materials must be nonflammable and self extinguishing.
- The screw must not become loose due to vibration.
- The current carrying bar must have such a form that the conductor has a strong contact area in the connection point. The terminal block series should have a complete range together with all the accessories to provide the best solutions in a minimum area.

Les bornes de jonction sont des composants ou des ensembles dont la fonction principale est d'assurer et de sécuriser les connexions électriques et mécaniques des conducteurs. Ceci correspond à toutes les formes et types de connexion. Pratiquement il s'agit surtout des bornes de jonction modulaires montées sur rails.

- La barre qui transmet le courant est métallique afin de réduire les pertes électriques.
- Les matériaux isolants doivent être ininflammables et auto-extinguibles.
- Les vis ne doivent pas se desserrer sous l'effet des vibrations.
- La forme de la barre qui transmet le courant doit être conçue de telle façon que le contact au point de connexion soit le plus fort possible.
- Il est important de pouvoir offrir toute la gamme d'accessoires afin d'obtenir la solution optimum dans un espace restreint.

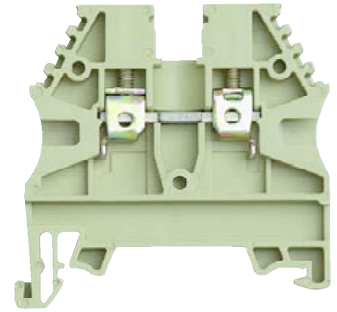

Connection systems

12

SCREW CONNECTIONS:

This is the most popular of all known methods of connection. Screw connection refers to any connection in which the conductor is stripped of its insulation and clamped without any special preparation. IMO screw clamp system has a built in protection against loosening.

When the screw is tightened, the resultant pressure pulls apart both halves of the clamping yoke. This generates a particularly high locking action on the screw. These clamping systems provide excellent vibration resistance.

SPRING CLAMP SYSTEM:

The stainless steel spring presses the conductor directly against the current bar. Due to the special construction of the clamping body the contact force is further increased when pulling the conductor.

Systèmes de connexions

CONNEXIONS À VIS:

Ce type de connexion est le plus couramment utilisé. Il est indiqué lorsque le conducteur est dénudé et serré dans la borne sans autre préparation. La vis de verrouillage est protégée contre le desserrement.

En serrant la vis on exerce une pression sur les deux parties de la cage de verrouillage ce qui engendre un blocage mécanique de la vis. Ce système est excellent contre les vibrations

SYSTÈME À RESSORT:

Le ressort en acier inoxydable pousse le conducteur sur la barre de courant. Grâce à la conception spéciale du ressort la force de contact augmente lorsque l'on tire sur le conducteur.

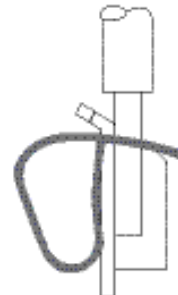
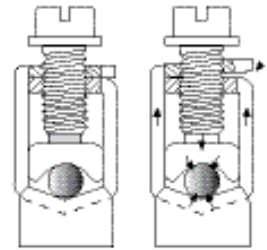
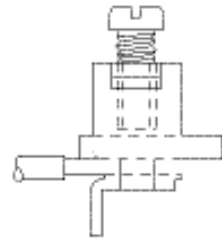

Materials

IMO terminals are made of carefully selected standard materials. Insulating materials, clamping metals and conducting metals are subjected to strict quality control as required by stringent international standards.

Clamping yokes and screws are zinc plated which considerably increases the resistance to corrosion. Current bars are made out of brass / electrolytic copper. Coating of tin / lead oxide, nickel while ensuring surface protection guarantees very low contact resistance.

Engineering Thermoplastic Polyamide 6.6 has excellent electrical, mechanical and chemical characteristics even at temperatures as high as 100°C and contain no cadmium based colour pigments. Polyamide 6.6 moulded housing absorbs humidity from its surroundings. This makes the plastic material elastic and fracture proof even at temperatures as low as -40°C. Being a self extinguishing material it is difficult to ignite and burns only as long as there is a supporting flame. It is rated V2 according to UL94. Good aging resistance and insensitivity to ultraviolet light makes it suitable for tropical and open air applications.

Main terminology

Modular Terminal Blocks: Modular terminal blocks are used worldwide. Whether they be in distribution boards, control centres or machine control systems, in ships, power stations or railway rolling stock, IMO terminals guarantee safe connections in all low voltage installations. In view of this versatile and worldwide application, the materials use and the technical data achieved meet the highest quality standard. Approvals have been obtained from all major industrial countries

Rated Cross Section: Rated cross section is the largest solid, stranded or flexible conductor cross section which can be clamped in a terminal.

Rated Thermal Current: Rated thermal current is the load current which the terminal block can carry continuously under fixed conditions without being subjected to inadmissible overheating.

Rated Voltage: Rated voltage is the electrical voltage for which the terminal block has been insulated and dimensioned.

Nominal Dimensions: Nominal dimensions are the overall dimensions of the terminal block with fixings, but without tolerances. To the specified terminal with a tolerance of +0.2 mm must be allowed during design when mounting in rows.

Insulation Stripping Length: The required stripping length for every IMO product is stated in mm. These lengths must be observed

End Plate: The last terminal in a rail mounted assembly must be closed with an end plate. The end plate is held in position by the end bracket.

Partition: The partition is required for the visual separation of circuits or electrical separation in case of adjacent cross connections.

Small Partitions: Small partitions can be inserted after assembly into terminal blocks of up to a max thickness of 10mm between cross connection and test sockets.

Matériaux

Les bornes de jonction IMO sont fabriquées avec des matériaux standard sélectionnés avec soin. Les matériaux d'isolation, de serrage et les conducteurs sont soumis à des contrôles stricts et répondent aux exigences des normes internationales.

Les mécanismes de serrage et les vis sont zingués ce qui augmente considérablement la résistance à la corrosion. Les conducteurs sont faits de cuivre électrolytique brasé, les contacts en nickel recouverts d'une couche d'oxyde étain/plomb ce qui garantit une bonne protection et une résistance de contact très basse.

Le polyamide 6.6 a d'excellentes caractéristiques électriques, mécaniques, et chimiques même à des températures de 100° et les pigments de coloration ne contiennent pas de cadmium. Les boîtiers en polyamide 6.6 absorbent l'humidité environnante. Cette matière plastique reste élastique et incassable même à des températures aussi basses que -40°C. Etant auto-extinguible ce matériau est difficile à enflammer et ne brûle que s'il y a une flamme soutenue. Il est classé V2 selon les normes UL 94. Il résiste bien au temps et aux UV, si bien qu'on peut l'utiliser pour l'extérieur ou pour des applications tropicales.

Glossaire

Bornes de jonction: Les bornes de jonction sont universellement connues. Que ce soit dans les armoires de commande, dans les centres de contrôle, dans les systèmes de contrôle de machines, dans les navires, les centrales électriques ou les chemins de fer, les bornes de jonction IMO garantissent une connexion sûre pour toutes les applications basse tension. Les matériaux utilisés et les caractéristiques techniques permettent d'atteindre des standards de très haute qualité correspondant aux normes de tous les grands pays industriels.

Section nominale: La section nominale correspond à la section du plus grand conducteur monobrin ou multibrin qui peut être utilisé dans une borne.

Courant thermique maximal: Le courant thermique maximal est le plus fort courant qu'une borne peut supporter sans échauffement dommageable.

Tension nominale: La tension nominale est la tension pour laquelle la borne a été dimensionnée et isolée.

Dimensions nominales: Les dimensions nominales sont les dimensions totales de la borne avec les fixations mais sans les tolérances. Dans une rangée il faut prévoir une tolérance de +0,2 mm par borne.

Longueur de dénudage: Ces longueurs sont données en mm. Elles doivent être respectées.

Borne d'extrémité: Cette borne se monte à l'extrémité d'un assemblage. Elle est fixée à l'aide d'une équerre adaptée.

Partition: La partition est nécessaire pour une séparation visuelle des circuits ou pour une séparation électrique, dans le cas d'utilisation de shunts.

Petite partition: Les petites partitions peuvent être insérées après assemblage sur une largeur maximum de 10 mm entre shunts et points test.

T15 Series

Mini Terminals for TS 15 Rails
Mini Bornes pour Rails TS 15

Screw type mini terminals are designed as a result of the studies for the necessity of making terminal connections within enclosures which are getting smaller everyday. These terminals providing 2.5 mm² and 4 mm² cable connections are mounted on TS 15x5.5 mounting rails. Both cross sections have the same dimensions and a common end plate that can be used for all the range. The terminals are fixed by each other by the pins forming blocks and provide users to make cross connections with patented cross connection system of CCS without keeping extra stock.

Les mini bornes ont été conçues à la suite d'études portant sur la nécessité de faire les connexions dans des armoires dont la taille se réduit de jour en jour. Ces bornes admettant des fils de sections de 2,5 mm² et 4 mm² se montent sur les rails TS 15x5,5 mm.

Les deux bornes ont les mêmes dimensions et le même capot d'extrémité qui peut être utilisé pour l'ensemble de la gamme. Les bornes se fixent les unes aux autres grâce aux broches, elles forment ainsi un bloc et permettent aux utilisateurs de les interconnecter grâce au système de barrettes de connexion breveté, CCS, sans avoir à mettre en place un stock supplémentaire.

ER2.5-T15

Width/Largeur 5mm
304 420i BEIGE/BEIGE
304 429i GREY/GRIS

ER4-T15

Width/Largeur 6mm
304 430i BEIGE/BEIGE
304 439i GREY/GRIS

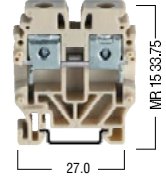
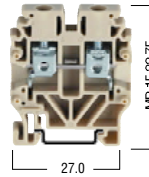

Electrical ratings/Puissance nominale électrique					
Voltage/Current/Cross section /Tension/Courant/Section nominale		400V~ /24A /2.5mm ²		400V~ /32A /4mm ²	
Insulation stripping length/Longueur de dénudement		10mm		10mm	
Connection Data/Caractéristiques des connexions					
Solid Strand, Screw Connection/Fil rigide, connexion à vis		0.5-4mm ²		0.5-6mm ²	
Fine Strand, Screw Connection/Fil fin, connexion à vis		1.5-2.5mm ²		1.5-4mm ²	
AWG Conductor/Conducteur AWG		26.....12		26.....10	
Ordering Data/Références		Cat.No/No.Cat. Qty/Qt.		Cat.No/No.Cat. Qty/Qt.	
Polyamide 6.6					
BEIGE/BEIGE		304 420i 100		304 430i 100	
GREY/GRIS		304 429i 100		304 439i 100	
End Bracket/Capot d'extrémité					
Thickness/Epaisseur 8mm		BEIGE/BEIGE ES5 495 060i 100		BEIGE/BEIGE ES5 495 060i 100	
GREY/GRIS ES5		GREY/GRIS ES5 495 069i 100		GREY/GRIS ES5 495 069i 100	
End Plate/Partition/Plaque d'extrémité					
Thickness/Epaisseur 1.5mm		BEIGE/BEIGE EP1.5-4 444 420i 100		BEIGE/BEIGE EP1.5-4 444 420i 100	
GREY/GRIS EP1.5-4		GREY/GRIS EP1.5-4 444 429i 100		GREY/GRIS EP1.5-4 444 429i 100	
Polyamide 6.6					
Cross-Connection/Barrettes de jonction					
CCS 2.5/2		476 222i 25		CCS 4/2 476 232i 25	
CCS 2.5/3		476 223i 20		CCS 4/3 476 233i 20	
CCS 2.5/4		476 224i 15		CCS 4/4 476 234i 15	
CCS 2.5/10		476 229i 5		CCS 4/10 476 239i 5	

Colours Couleurs	Terminals Bornes	End Plate Plaque d' extrémité
	ER2.5-T15	EP1.5-4
BEIGE/BEIGE	304 420i	444 420i
BLUE/BLEU	304 421i	444 421i
GREEN/VERT	304 422i	444 422i
YELLOW/JAUNE	304 423i	444 423i
RED/ROUGE	304 424i	444 424i
GREY/GRIS	304 429i	444 429i

T15 Series

Mini Earth Terminals
for TS 15 Rails
Mini Bornes de Terre pour
Rails TS 15

ERPE 2.5-T15

Width/Largeur 5mm
334 420i

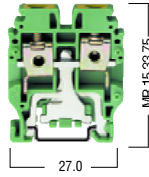

ERPE 4-T15

Width/Largeur 6mm
334 430i

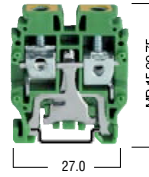

Electrical ratings/Puissance nominale électrique							
Voltage/Current/Cross section /Tension/Courant/Section nominale		-V~ /-A /2.5mm ²		-V~ /-A /4mm ²			
Insulation stripping length/Longueur de dénudement		10mm		10mm			
Connection Data/Caractéristiques des connexions							
Solid Strand, Screw Connection/Fil rigide, connexion à vis		0.5-4mm ²		0.5-6mm ²			
Fine Strand, Screw Connection/Fil fin, connexion à vis		1.5-2.5mm ²		1.5-4mm ²			
AWG Conductor/Conducteur AWG		26.....12		26.....10			
Ordering Data/Références			Cat.No/No.Cat.	Qty/Qt.	Cat.No/No.Cat.	Qty/Qt.	
Polyamide 6.6	YELLOW/JAUNE/GREEN/VERDE		334 420i	50	334 430i	50	
End Bracket/Capot d'extrémité							
Thickness/Epaisseur 8mm	BEIGE/BEIGE	ES5	495 060i	100	ES5	495 060i	100
	GREY/GRIS	ES5	495 069i	100	ES5	495 069i	100
End Plate/Partition/Plaque d'extrémité							
Thickness/Epaisseur 1.5mm	GREEN/VERDE	EP1.5-4-GREEN	444 422i	100	EP1.5-4-GREEN	444 422i	100
	Polyamide 6.6	EP1.5-4					

Colours Couleurs	Terminals Bornes	End Plate Plaque d' extrémité
	ER4-T15	EP1.5-4
BEIGE/BEIGE	304 430i	444 420i
BLUE/BLEU	304 431i	444 421i
GREEN/VERT	304 432i	444 422i
YELLOW/JAUNE	304 433i	444 423i
RED/ROUGE	304 434i	444 424i
GREY/GRIS	304 439i	444 429i

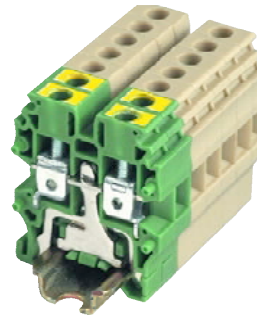

ER Series

Feed-through Terminals and Accessories Bornes Traversantes et Accessoires

ER type terminals are manufactured from thermoplastic raw materials. Beige is the main colour, 8 different colours give users chance for grouping.

Les bornes ER sont fabriquées en matériaux thermoplastiques. La couleur standard est le beige. 8 couleurs disponibles peuvent permettre à l'utilisateur d'effectuer des groupages.

Colours Couleurs	Terminals Bornes	End Plate Plaque d'extrémité
	ER 2.5	EP
GREY/GRIS	304 120i	444 120i
BLUE/BLEU	304 121i	444 121i
GREEN/VERT	304 122i	444 122i
YELLOW/JAUNE	304 123i	444 123i
RED/ROUGE	304 124i	444 124i
BLACK/NOIR	304 125i	444 125i
ORANGE/ORANGE	304 127i	444 127i
WHITE/BLANC	304 126i	444 126i
	ER 4	EP
GREY/GRIS	304 130i	444 120i
BLUE/BLEU	304 131i	444 121i
GREEN/VERT	304 132i	444 122i
YELLOW/JAUNE	304 133i	444 123i
RED/ROUGE	304 134i	444 124i
BLACK/NOIR	304 135i	444 125i
ORANGE/ORANGE	304 137i	444 127i
WHITE/BLANC	304 136i	444 126i

ER 2.5



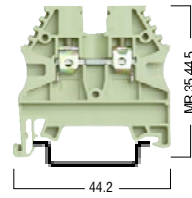



Width/Largeur 5mm
304 129i

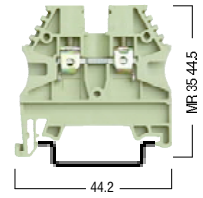

ER 4

Width/Largeur 6mm
304 139i



Electrical ratings/Puissance nominale électrique					
Voltage/Current/Cross section /Tension/Courant/Section nominale		750V~/26A/2.5mm ²		750V~/34A/4mm ²	
VDE/VDE		750V~/24A/2.5mm ²		750V~/32A/4mm ²	
UL/UL		600V~/20A/AWG 26-12		600V~/30A/AWG 26-10	
Insulation stripping length/Longueur de dénudement		10mm		10mm	
Connection Data/Caractéristiques des connexions					
Solid Strand, Screw Connection/Fil rigide, connexion à vis		0.5-4mm ²		0.5-6mm ²	
Fine Strand, Screw Connection/Fil fin, connexion à vis		1.5-2.5mm ²		1.5-4mm ²	
AWG Conductor/Conducteur AWG		26.....12		26.....10	
Ordering Data/Références		Cat.No/No.Cat. Qty/Qt.		Cat.No/No.Cat. Qty/Qt.	
Polyamide 6.6		304 129i	100	304 139i	100
Mounting Rails/Rails de montage		Type/Genre		Type/Genre	
MR 35 x 7.5		DINRAIL1M-SLOT	1m	DINRAIL1M-SLOT	1m
MR 35 x 7.5 Slotted/Encoche Unslotted/Sans encoche		DINRAIL1M-UNSLLOT	1m	DINRAIL1M-UNSLLOT	1m
DIN EN 50022		TS35x7.5 DINRAIL	2m	TS35x7.5 DINRAIL	2m
		DINRAIL2M-UNSLLOT	2m	DINRAIL2M-UNSLLOT	2m
End Bracket/Capot d'extrémité		Qty/Qt.		Qty/Qt.	
For/Pour MR 35		ES3	495 030i 100	ES3	495 030i 100
 ES1		ES1	495 040i 100	ES1	495 040i 100
End Plate/Partition/Plaque d'extrémité					
Thickness/Epaisseur 1.5mm Polyamide 6.6		EP 2.5-10	444 129i 100	EP 2.5-10	444 129i 100
 EP					
Small Partition/Petite séparation					
Small Partition/Petite séparation Large Partition/Séparation large		SP1	467 910i 100	SP1	467 910i 100
 SP1/SP2.5-10		SP2.5-10	462 120i 100	SP2.5-10	462 120i 100
Cross-Connection/Barrettes de jonction					
		CC 2.5/2	474 122i 25	CC 4/2	474 132i 25
		CC 2.5/3	474 123i 20	CC 4/3	474 133i 20
		CC 2.5/4	474 124i 15	CC 4/4	474 134i 15
		CC 2.5/10	474 129i 5	CC 4/10	474 139i 5
Test Plug-Soc/Pointes de test					
		TF (Ø2)	493 020i 5	TF (Ø2.3)	493 023i 5
		TF (Ø2.3)	493 023i 5	TF (Ø4)	493 040i 5
		TSK 1 (Ø2)	490 010i 5	TSK 4 (Ø2.3)	490 040i 5
		TSK 3 (Ø2.3)	490 030i 5	TSK 7 (Ø4)	490 070i 5
				ITK 28 (Ø4)	492 010i 5
Warning Label/Plaque d'alarme					
With symbol/Avec symbol Without symbol/Sans symbol		WL 1	498 133i 25	WL 1	498 133i 25
		WL 2	498 140i 25	WL 2	498 140i 25
Group Marking/Marquage de groupe					
		GM	496 110i 50	GM	496 110i 50
		GM 2	496 250i 25	GM 2	496 250i 25

ER 6

Width/Largeur 8mm
304 149i

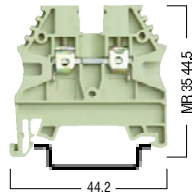

ER 10

Width/Largeur 10mm
304 159i

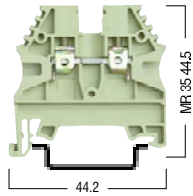

ER 16

Width/Largeur 12mm
304 169i

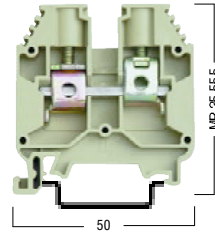

ER 35

Width/Largeur 16mm
304 179i

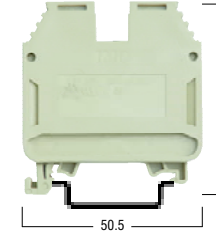

ER 70

Width/Largeur 22mm
304 199i

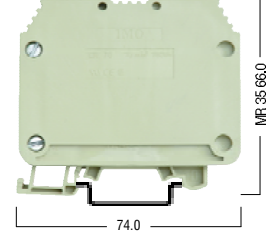

ER 6		ER 10		ER 16		ER 35		ER 70	
750V~ /44A/6mm ²	750V~ /61A/10mm ²	750V~ /82A/10mm ²	750V~ /135A/35mm ²	750V~ /192A/70mm ²					
630V~ /41A /6mm ²	630V~ /57A /10mm ²	630V~ /76A /10mm ²	750V~ /125A /35mm ²						
600V~ /50A /AWG 26-8	600V~ /65A /AWG 16-6	600V~ /85A /AWG 12-4	600V~ /115A /AWG 10-2	600V~ /175A /AWG 6-2/0					
12mm	12mm	16mm	18mm	20mm					
0.5-10mm ²	1.5-16mm ²	1.5-16mm ²	6-16mm ²	10-16mm ²					
1.5-6mm ²	1.5-10mm ²	1.5-16mm ²	10-35mm ²	10-70mm ²					
26.....8	16.....6	14.....4	8.....1	6.....2/0					
Cat.No/No.Cat. Qty/Qt.	Cat.No/No.Cat. Qty/Qt.	Cat.No/No.Cat. Qty/Qt.	Cat.No/No.Cat. Qty/Qt.	Cat.No/No.Cat. Qty/Qt.					
304 149i 100	304 159i 100	304 169i 50	304 179i 50	304 199i 10					
Type/Genre	Type/Genre	Type/Genre	Type/Genre	Type/Genre					
DINRAIL1M-SLOT 1m	DINRAIL1M-SLOT 1m	DINRAIL1M-SLOT 1m	DINRAIL1M-SLOT 1m	DINRAIL1M-SLOT 1m					
DINRAIL1M-UNSLLOT 1m	DINRAIL1M-UNSLLOT 1m	DINRAIL1M-UNSLLOT 1m	DINRAIL1M-UNSLLOT 1m	DINRAIL1M-UNSLLOT 1m					
TS35x7.5 DINRAIL 2m	TS35x7.5 DINRAIL 2m	TS35x7.5 DINRAIL 2m	TS35x7.5 DINRAIL 2m	TS35x7.5 DINRAIL 2m					
DINRAIL2M-UNSLLOT 2m	DINRAIL2M-UNSLLOT 2m	DINRAIL2M-UNSLLOT 2m	DINRAIL2M-UNSLLOT 2m	DINRAIL2M-UNSLLOT 2m					
Qty/Qt.	Qty/Qt.	Qty/Qt.	Qty/Qt.	Qty/Qt.					
ES3 495 030i 100	ES3 495 030i 100	ES3 495 030i 100	ES3 495 030i 100	ES3 495 030i 100					
ES1 495 040i 100	ES1 495 040i 100	ES1 495 040i 100	ES1 495 040i 100	ES1 495 040i 100					
EP 2.5-10 444 129i 100	EP 2.5-10 444 129i 100	EP 16 444 169i 100							
SP1 467 910i 100	SP1 467 910i 100								
SP2.5-10 462 120i 100	SP2.5-10 462 120i 100								
CC 6/2 474 142i 25	CC 10/2 474 152i 25	CC 16/2 474 162i 25	CC 35/2 474 172i 25						
CC 6/3 474 143i 20	CC 10/3 474 153i 20	CC 16/3 474 163i 20	CC 35/3 474 173i 20						
CC 6/4 474 144i 15	CC 10/4 474 154i 15	CC 16/4 474 164i 15	CC 35/4 474 174i 15						
CC 6/10 474 149i 5	CC 10/10 474 159i 5	CC 16/10 474 169i 5	CC 35/10 474 179i 5						
TF (Ø2.3) 493 023i 5	TF (Ø2.3) 493 023i 5	TF (Ø4) 493 040i 5	TF (Ø4) 493 040i 5						
TF (Ø4) 493 040i 5	TF (Ø4) 493 040i 5								
TSK 4 (Ø2.3) 490 040i 5	TSK 4 (Ø2.3) 490 040i 5	TSK 8 (Ø4) 490 080i 5	TSK 9 (Ø4) 490 090i 5						
TSK 7 (Ø4) 490 070i 5	TSK 7 (Ø4) 490 070i 5								
ITK 28 (Ø4) 492 010i 5	ITK 28 (Ø4) 492 010i 5	ITK 32 (Ø4) 492 020i 5							
WL 1 498 133i 25	WL 1 498 133i 25								
WL 2 498 140i 25	WL 2 498 140i 25	WL 3 498 143i 25	WL 3 498 143i 25						
GM 496 110i 50	GM 496 110i 50	GM 496 110i 50	GM 496 110i 50	GM 496 110i 50					
GM 2 496 250i 25	GM 2 496 250i 25	GM 2 496 250i 25	GM 2 496 250i 25						

ER 4C Series

One Input Two Output Terminals
Bornes à une Entrée et Deux Sorties









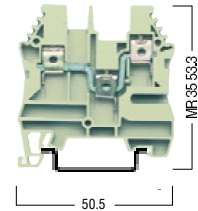





ER 4C provides one terminal point on one side and two terminal points on the other connection side. Bridging is provided at the centre of the terminal. It is possible to use the jumpers of ER4, standard 4mm² terminal block, for cross connection purposes without keeping extra stock.

La série ER 4C fournit un point d'entrée d'un côté et deux points de sortie de l'autre. La liaison se fait au centre de la borne. Il est possible d'utiliser les shunts de la série standard 4 mm² ce qui permet de limiter les stocks.

ER 4C

Width/Largeur 6mm
325 100i BEIGE/BEIGE



Electrical ratings/Puissance nominale électrique				
Voltage/Current/Cross section/Tension/Courant/Section nominale	750V~/32A/4mm ²			
Insulation stripping length/Longueur de dénudement	10mm			
Connection Data/Caractéristiques des connexions				
Solid Strand, Screw Connection/Fil rigide, connexion à vis	0.5-6mm ²			
Fine Strand, Screw Connection/Fil fin, connexion à vis	1.5-4mm ²			
AWG Conductor/Conducteur AWG	26.....10			
Ordering Data/Références			Cat.No/No.Cat	Qty./Qt.
Polyamide 6.6	BEIGE/BEIGE		325 100i	50
YELLOW/JAUNE/GREEN/VERT				
Mounting Rails/Rails de montage		Type/Genre		
MR 35 x 7.5		DINRAIL1M-SLOT		1m
MR 35 x 7.5 Slotted/Encoche		DINRAIL1M-UNSLLOT		1m
Unslotted/Sans encoche		TS35x7.5 DINRAIL		2m
	DIN EN 50022	DINRAIL2M-UNSLLOT		2m
End Bracket/Capot d'extrémité			Qty./Qt.	
	ES1	For/Pour MR 35 & MR 35	ES3	495 030i 100
		For/Pour MR 35	ES1	495 040i 100
End Plate/Partition/Plaque d'extrémité				
Thickness/Epaisseur	1.5mm	BEIGE/BEIGE	EP4C	450 170i 10
		Polyamide 6.6		
	EP4C			
Cross-Connection/Barrettes de jonction				
			CC4/2C	480 142i 25
			CC4/3C	480 143i 20
			CC4/4C	480 144i 15
			CC4/10C	480 149i 5
Test Plug-Soc/Pointes de test				
			TF (Ø2.3)	493 023i 5
			TF (Ø4)	493 040i 5
			TSK 4 (Ø2.3)	490 040i 5
			TSK 7 (Ø4)	490 070i 5
			ITK 28(Ø4)	492 010i 5
Warning Label/Plaque d'alarme				
		With symbol/Avec symbol	WL1	498 133i 25
		Without symbol/Sans symbol	WL2	498 143i 25
Group Marking/Marquage de groupe				
	GM/GM2	BEIGE/BEIGE	GM	496 110i 50
			GM 2	496 250i 25

ERPE Series

Earth Terminals
Bornes de terre

ERPE 2.5/4

Width/Largeur 10mm
334 120i



ERPE 6/10

Width/Largeur 10mm
334 140i

ERPE 16/35

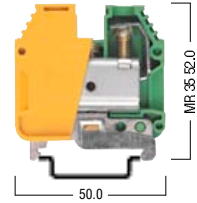
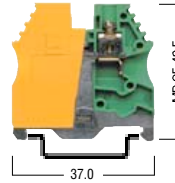
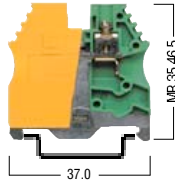
Width/Largeur 16mm
334 160i



Electrical ratings/Puissance nominale électrique								
Voltage/Current/Cross section /Tension/Courant/Section nominale	~V~/~A/4mm ²		~V~/~A/10mm ²		~V~/~A/35mm ²			
VDE/VDE	~V~/~A/4mm ²		~V~/~A/10mm ²		~V~/~A/35mm ²			
UL/UL	AWG 26/10		AWG 16-8		AWG 8-2			
Insulation stripping length/Longueur de dénudement	10mm		12mm		18mm			
Connection Data/Caractéristiques des connexions								
Solid Strand, Screw Connection/Fil rigide, connexion à vis	0.5-6mm ²		1.5-16mm ²		6-16mm ²			
Fine Strand, Screw Connection/Fil fin, connexion à vis	1.5-4mm ²		1.5-10mm ²		10-35mm ²			
AWG Conductor/Conducteur AWG	26.....10		16.....6		8.....1			
Ordering Data/Références								
Polyamide 6.6	Cat.No/No.Cat		Qty/Qt.		Cat.No/No.Cat		Qty/Qt.	
	BEIGE/BEIGE							
	YELLOW/JAUNE/GREEN/VERT		334 120i 50		334 140i 50		334 160i 25	
Mounting Rails/Rails de montage								
	Type/Genre		Type/Genre		Type/Genre			
MR 35 x 7.5	DINRAIL1M-SLOT		1m		DINRAIL1M-SLOT		1m	
MR 35 x 7.5 Slotted/Encoche	DINRAIL1M-UNSLLOT		1m		DINRAIL1M-UNSLLOT		1m	
Unslotted/Sans encoche 	TS35x7.5 DINRAIL		2m		TS35x7.5 DINRAIL		2m	
	DINRAIL2M-UNSLLOT		2m		DINRAIL2M-UNSLLOT		2m	
Group Marking/Marquage de groupe								
	GM BEIGE/BEIGE		GM 496 110i 50		GM 496 110i 50		GM 496 110i 50	

ERPE series earth terminals can only be used on rail MR 35 and their colours are yellow-green which complies with international standards. Metal parts connect wire directly to rail which terminal is assembled.

La série ERPE est constituée de bornes de terre. Elles ne peuvent être utilisées que sur des rails M35 et leur couleur est jaune/vert conformément aux normes internationales. Les parties métalliques sont reliées directement au rail sur lequel les bornes sont installées.

ERB Series

High Current Terminals Bornes à Courant Élevé

ERB type rail mounted terminal blocks are developed in order to have safe connections of high current carrying conductors. In this type of rail terminals, cable connection is done by cable lugs connected to the tips of the conductor. Isolation cover is designed for cable lugs having different dimensions. Cross connection up to 4 poles is available. Due to its universal structure, it is possible to mount ERB on MR 32 & MR 35 rails. A fixing screw is available in order to maintain a more secure mounting on the DIN rail.

La série ERB est constituée de bornes qui ont été développées pour pouvoir supporter des courants forts. Dans ce type de borne, la connexion se fait avec des câbles équipés de cosses. Un couvercle isolant est prévu pour des câbles de section différentes. Des shunts jusqu'à 4 pôles sont disponibles. Grâce à leur structure universelle, il est possible de monter la série ERB sur des rails MR 32 et MR 35. Des vis de fixation sont disponibles afin d'obtenir un montage sécurisé sur le rail DIN.

ERB 95

Width/Largeur 40mm
304 309i

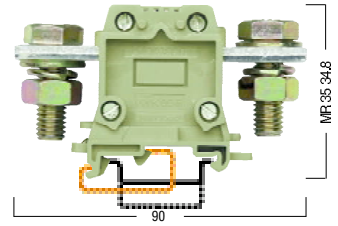

Electrical ratings/Puissance nominale électrique

Voltage/Current/Cross section/Tension /Courant /Section nominale 1000V~/232A/95mm²

Insulation stripping length/Longueur de dénudement

Ordering Data/Références

Cat.No/No.Cat

Qty/Qt.

304 309i

5

Mounting Rails/Rails de montage

Type/Genre

MR 32

MR 35 x 7.5

MR 35 x 7.5

Slotted/Encoche

Unslotted/Sans encoche



DIN EN 50025

DIN EN 50022

DINRAIL1M-SLOT	1m
DINRAIL1M-UNSLLOT	1m
TS35x7.5 DINRAIL	2m
DINRAIL1M-UNSLLOT	2m
MR 32	1m

Isolation Cover/Capot d'isolation

Qty/Qt.



IC95

466 109i

4

Cross Connection/Shunt



CCB 95/2

478 302i

5

CCB 95/3

478 303i

5

CCB 95/4

478 304i

5

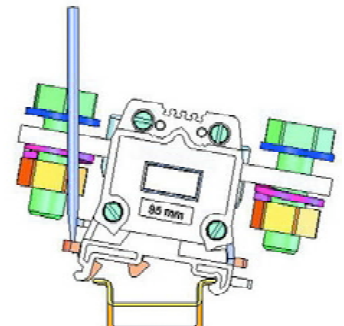
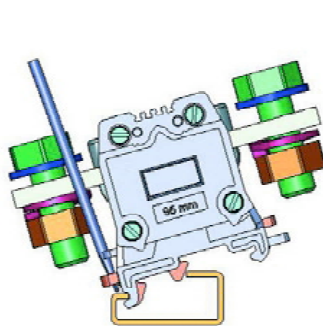

ERB 150

Width/Largeur 48mm
304 319i

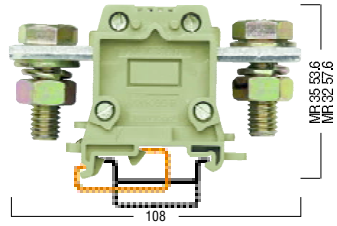

ERB 240

Width/Largeur 53mm
304 329i

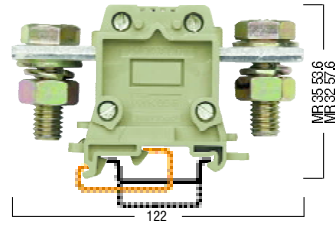

1000V~/309A/150mm ²		1000V~/415A/240mm ²			
Cat.No/No.Cat	Qty/Ot.	Cat.No/No.Cat	Qty/Ot.		
304 319i	5	304 329i	5		
Type/Genre		Type/Genre			
DINRAIL1M-SLOT	1m	DINRAIL1M-SLOT	1m		
DINRAIL1M-UNSLLOT	1m	DINRAIL1M-UNSLLOT	1m		
TS35x7.5 DINRAIL	2m	TS35x7.5 DINRAIL	2m		
DINRAIL1M-UNSLLOT	2m	DINRAIL1M-UNSLLOT	2m		
MR 32	1m	MR 32	1m		
Qty/Ot.		Qty/Ot.			
IC150	466 119i	4	IC240	446 129i	4
CCB 150/2	478 312i	5	CCB 240/2	478 322i	5
CCB 150/3	478 313i	5	CCB 240/3	478 323i	5
CCB 150/4	478 314i	5	CCB 240/4	478 324i	5

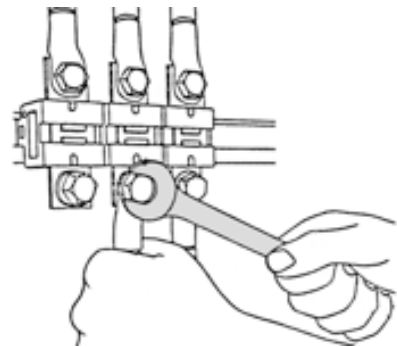
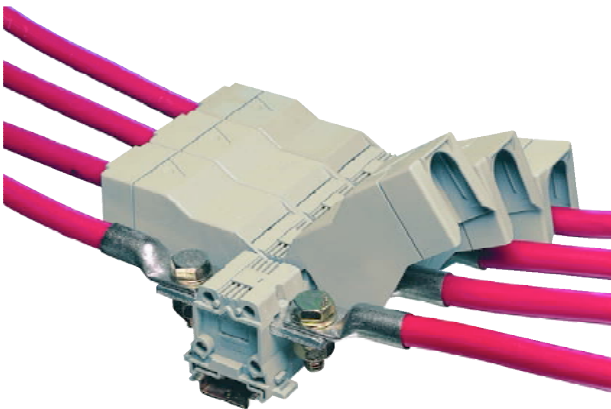

ERD 2.5 Series

Double-Deck Terminals Bornes à Deux Niveaux

IMO double level terminals are the answer to high wiring density problems posed by certain unavoidable wiring arrangements. Besides this, the double level terminals have the following advantages:

- Double wiring density available without extension mounting rails
- Interconnection/shorting can be done at both levels
- Marking/identification by making tags possible at both levels.

Les bornes à deux niveaux IMO autorisent une haute densité de câblage. Elles offrent les avantages suivants:

- La densité de câblage est double sur la même longueur de rail.
- Les connexions internes peuvent être faites sur les deux niveaux.
- Le marquage peut, lui aussi, être fait sur les deux niveaux.

ERD 2.5

Width/Largeur 5mm
317 100i BEIGE/BEIGE

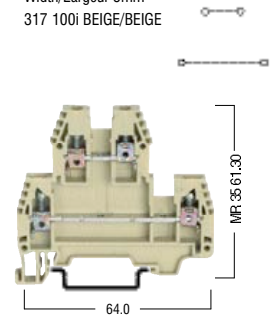

Electrical ratings/Puissance nominale électrique

Voltage/Current/Cross section /Tension /Courant/Section nominale 750V~/24A/2.5mm²

UL/cUL

Insulation stripping length/Longueur de dénudement 9mm

Connection Data/Caractéristiques des connexions

Solid Strand, Screw Connection/Fil rigide, connexion à vis 0.5.....4mm²

Fine Strand, Screw Connection/Fil fin, connexion à vis 1.5.....2.5mm²

AWG Conductor/Conducteur AWG 26.....12

Ordering Data/Références

Type/Genre	Cat.No/No.Cat	Qty/Qt.
Polyamide 6.6	ERD 2.5 317 100i	100

Electrical Ratings/Puissance nominale électrique

Diode Reverse Voltage/Diode à tension inverse

Diode Current/Courant de diode

Diode/Diode

Mounting Rails/Rails de montage

Type/Genre	Qty/Qt.
MR 35 x 7.5 DINRAIL1M-SLOT	1m
MR 35 x 7.5 Slotted/Encoche Unslotted/Sans encoche	DINRAIL1M-UNSL0T 1m
DIN EN 50022	TS35x7.5 DINRAIL 2m
	DINRAIL2M-UNSL0T 2m

End Bracket/Capot d'extrémité

Type/Genre	Cat.No/No.Cat	Qty/Qt.
For/Pour MR 35 & MR 35 BEIGE/BEIGE ES1	ES3 495 030i	100
For/Pour MR 35 BEIGE/BEIGE	ES1 495 040i	100

End Plate/Partition/Plaquette d'extrémité

Type/Genre	Cat.No/No.Cat	Qty/Qt.
BEIGE/BEIGE EP4 Polyamide 6.6 Thickness/Epaisseur 1.5mm	EP4 449 010i	25

Cross-Connection/Barrettes de jonction

	CC2.5/2 474 122i	25
	CC2.5/3 474 123i	20
	CC2.5/4 474 124i	15
	CC2.5/10 474 129i	5

Test Plug-Soc/Pointes de test

	TF (Ø.2) 493 023i	5
	TF (Ø.2.3) 493 040i	5
	TSK 3 (Ø2.3) 490 070i	5
	TSK1 28 (Ø.1) 492 010i	5

Group Marking/Marquage de groupe

	GM BEIGE/BEIGE GM	496 110i	50
--	-------------------	----------	----

ERD 2.5V

Width/Largeur 5mm
317 120i BEIGE/BEIGE



ERD 2.5D

Width/Largeur 5mm
317 220i BEIGE/BEIGE



ERD 2.5LD

Width/Largeur 5mm



ERD 2.5LD

Width/Largeur 5mm

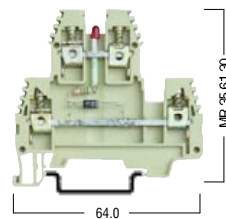
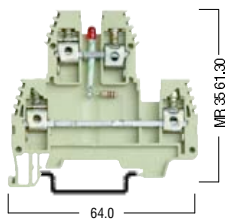
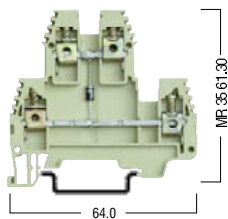
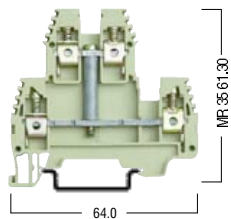

750V~/24A/2.5mm²		750V~/24A/2.5mm²		750V~/24A/2.5mm²		750V~/24A/2.5mm²		
9mm		9mm		9mm		9mm		
0.5.....4mm²		0.5.....4mm²		0.5.....4mm²		0.5.....4mm²		
1.5.....2.5mm²		1.5.....2.5mm²		1.5.....2.5mm²		1.5.....2.5mm²		
26.....12		26.....12		26.....12		26.....12		
Type/Genre	Cat.No/No.Cat	Qty/Qt.	Type/Genre	Cat.No/No.Cat	Qty/Qt.	Type/Genre	Cat.No/No.Cat	Qty/Qt.
ERD 2.5V	317 120i	20	ERD 2.5D	317 220i	20	ERD 2.5LD	317 320i (24 VDC)	20
						ERD 2.5LD	317 420i (48 VDC)	20
						ERD 2.5LD	317 620i (110 VDC)	20
						ERD 2.5LD	317 720i (220 VDC)	20
						ERD 2.5LD	317 310i (24 VAC)	20
						ERD 2.5LD	317 410i (48 VAC)	20
						ERD 2.5LD	317 610i (110 VAC)	20
						ERD 2.5LD	317 710i (220 VAC)	20
			1000V					
			1A					
			1N 4007					
Type/Genre			Type/Genre			Type/Genre		
DINRAIL1M-SLOT	1m		DINRAIL1M-SLOT	1m		DINRAIL1M-SLOT	1m	
DINRAIL1M-UNSLLOT	1m		DINRAIL1M-UNSLLOT	1m		DINRAIL1M-UNSLLOT	1m	
TS35x7.5 DINRAIL	2m		TS35x7.5 DINRAIL	2m		TS35x7.5 DINRAIL	2m	
DINRAIL2M-UNSLLOT	2m		DINRAIL2M-UNSLLOT	2m		DINRAIL2M-UNSLLOT	2m	
Type/Genre	Cat.No/No.Cat	Qty/Qt.	Type/Genre	Cat.No/No.Cat	Qty/Qt.	Type/Genre	Cat.No/No.Cat	Qty/Qt.
ES3	495 030i	100	ES3	495 030i	100	ES3	495 030i	100
ES1	495 040i	100	ES1	495 040i	100	ES1	495 040i	100
EP4	449 010i	25	EP4	449 010i	25	EP4	449 010i	25
TF (Ø.2)	493 023i	5	TF (Ø.2)	493 023i	5	TF (Ø.2)	493 023i	5
TF (Ø.2.3)	493 040i	5	TF (Ø.2.3)	493 040i	5	TF (Ø.2.3)	493 040i	5
TSK 3 (Ø2.3)	490 070i	5	TSK 3 (Ø2.3)	490 070i	5	TSK 3 (Ø2.3)	490 070i	5
TSK1 28 (Ø.1)	492 010i	5	TSK1 28 (Ø.1)	492 010i	5	TSK1 28 (Ø.1)	492 010i	5
GM	496 110i	50	GM	496 110i	50	GM	496 110i	50

ERD 4 Series

Double-Deck Terminals

Bornes à Deux Niveaux

IMO double level terminals are the answer to high wiring density problems posed by certain unavoidable wiring arrangements. Besides this, the double level terminals have the following advantages:

- Double wiring density available without extension mounting rails
- Interconnection/shorting can be done at both levels
- Marking/identification by making tags possible at both levels.

Les bornes à deux niveaux IMO autorisent une haute densité de câblage. Elles offrent les avantages suivants:

- La densité de câblage est double sur la même longueur de rail.
- Les connexions internes peuvent être faites sur les deux niveaux.
- Le marquage peut, lui aussi, être fait sur les deux niveaux.

ERD 4

Width/Largeur 6mm
319 100i BEIGE/BEIGE

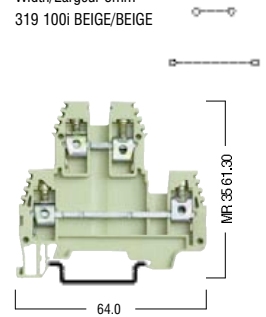

Electrical ratings/Puissance nominale électrique			
Voltage/Current/Cross section /Tension /Courant/Section nominale	750V~/34A/4mm ²		
VDE/VDE (IEC 60947-7-1)	500V~/32A/4mm ²		
UL/UL	300V~/32A/AWG 26-10		
Insulation stripping length/Longueur de dénudement	9mm		
Connection Data/Caractéristiques des connexions			
Solid Strand, Screw Connection/Fil rigide, connexion à vis	0.5.....6mm ²		
Fine Strand, Screw Connection/Fil fin, connexion à vis	1.5.....4mm ²		
AWG Conductor/Conducteur AWG	26.....10		
Ordering Data/Références			
Type/Genre	Cat.No/No.Cat	Qty./Qt.	
Polyamide 6.6.	ERD4	319 100i	100

Electrical Ratings/Puissance nominale électrique			
Diode Reverse Voltage/Diode à tension inverse			
Diode Current/Courant de diode			
Diode/Diode			
Mounting Rails/Rails de montage			
Type/Genre			
MR 35 x 7.5	DINRAIL1M-SLOT 1m		
MR 35 x 7.5 Slotted/Encoche	DINRAIL1M-UNSLLOT 1m		
Unslotted/Sans encoche	TS35x7.5 DINRAIL 2m		
	DINRAIL2M-UNSLLOT 2m		

End Bracket/Capot d'extrémité			
Type/Genre	Cat.No/No.Cat	Qty./Qt.	
For/Pour MR 35 & MR 35 BEIGE/BEIGE	ES3	495 030i	100
For/Pour MR 35 BEIGE/BEIGE	ES1	495 040i	100

End Plate/Partition/Plaquette d'extrémité			
Type/Genre	Cat.No/No.Cat	Qty./Qt.	
BEIGE/BEIGE Polyamide 6.6 Thickness/Epaisseur 1.5mm	EP4	449 010i	25

Cross-Connection/Barrettes de jonction			
Type/Genre	Cat.No/No.Cat	Qty./Qt.	
CC4/2	474 132i	25	
CC4/3	474 133i	20	
CC4/4	474 134i	15	
CC4/10	474 139i	5	

Test Plug-Soc/Pointes de test			
Type/Genre	Cat.No/No.Cat	Qty./Qt.	
TF (Ø.2)	493 023i	5	
TF (Ø.4)	493 040i	5	
TSK 4 (Ø2.3)	490 040i	5	
TSK 7 (Ø4)	490 070i	5	
ITK 28 (Ø4)	492 010i	5	

Group Marking/Marquage de groupe			
Type/Genre	Cat.No/No.Cat	Qty./Qt.	
GM BEIGE/BEIGE	GM	496 110i	50

ERT Series

Feed Through Terminal Blocks for Initiators, Actuators and Motors Bornes à Traversée pour Capteurs, Actionneurs et Moteurs

3 and 4 wired elements such as motors, sensors, actuators and initiators are commonly used in industry. The multi level terminal blocks (ERT 3, ERT 2E, ERT 3E) are designed and developed to meet the demanding requirements of 3 or 4 wire applications. Signal, power and ground can be connected on a single, compact 6mm width terminal block.

Multi level terminal blocks:

- Make wiring more practical
- Reduce the installation costs and speed the wiring.
- Provide individual cross connections for each layer. They are used at the edge of sensor terminal blocks
- Provide definitive identification of positive, negative and ground connections with the help of internationally accepted colours for the related layers. Because of this property, they minimise wiring mistakes and speed wiring
- Are ideal for limited spaces because of their compact designs.

Les composants à 3 ou 4 fils tels que les moteurs, les capteurs, les actionneurs, les détecteurs sont fréquemment utilisés dans l'industrie. Les bornes à niveaux multiples (ERT 3, ERT 2E, ERT 3E) ont été conçues et développées pour répondre aux exigences des applications à 3 ou 4 fils. Le signal, la puissance et la terre peuvent être connectés sur un simple bloc de jonction de 6 mm d'épaisseur.

Les bornes à niveaux multiples:

- Rendent le câblage plus pratique.
- Réduisent le coût de l'installation et le temps de câblage.
- Fournissent des connexions internes pour chaque niveau. Elles sont utilisées à l'extrémité des bornes de jonction pour détecteurs.
- Permettent une bonne identification du positif, du négatif et de la terre grâce aux couleurs aux normes internationales.
- Diminuent le temps de câblage et réduisent les erreurs.
- Sont idéales dans un espace limité grâce à leur concept compact.

ER T3

Width/Largeur 6mm
324 100i BEIGE/BEIGE

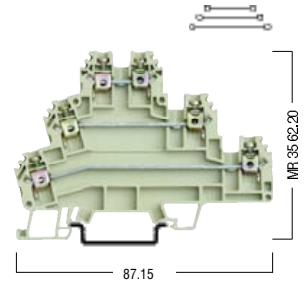

Electrical ratings/Puissance nominale électrique					
Voltage/Current/Cross section /Tension /Courant /Section nominale		500V~/24A/2.5mm ²			
VDE/VDE (IEC 60947-7-1)		400V~/24A/2.5mm ²			
UL/UL		300V~/24A/24...12AWG			
Insulation Stripping Length/Longueur de dénudement		9mm			
Connection Data/Caractéristiques des connexions					
Solid Strand, Screw Connection/Fil rigide, connexion à vis		0.5-4mm ²			
Fine Strand, Screw Connection/Fil fin, connexion à vis		1.5-2.5mm ²			
AWG Conductor/Conducteur AWG		26.....12			
Ordering Data/Références		Cat.No/No.Cat	Qty/Qt.		
Polyamide 6.6.	BEIGE/BEIGE	324 100i	25		
Mounting Rails/Rails de montage					
	Type/Genre				
MR 35 x 7.5	DINRAIL1M-SLOT		1m		
MR 35 x 7.5 Slotted/Encoche	DINRAIL1M-UNSLLOT		1m		
Unslotted/Sans encoche	TS35x7.5 DINRAIL		2m		
	DINRAIL2M-UNSLLOT		2m		
	DIN EN 50022				
End Bracket/Capot d'extrémité		Type/Genre	Cat.No/No.Cat	Qty/Qt.	
ES1	For/Pour MR 35 & MR 35	BEIGE/BEIGE	ES3	495 030i	100
			ES1	495 040i	100
End Plate/Partition/Plaque d'extrémité					
Thickness/Epaisseur 1.5mm	Polyamide 6.6	BEIGE/BEIGE	EP T3	450 130i	10
	EPT3				
	EPT3E				
	EPT2E				
Small Partition/Petite séparation					
	SP1	BEIGE/BEIGE	SP1	467 910i	100
Cross-Connection/Barrettes de jonction					
	CC 2.5/2T		480 132i	25	
	CC 2.5/3T		480 133i	20	
	CC 2.5/4T		480 134i	15	
	CC 2.5/10T		480 139i	5	
Test Plug-Soc/Pointes de test					
	TF (Ø2)		493 023i	5	
	TSK 3 (Ø2.3)		490 030i	5	
Group Marking/Marquage de groupe					
	GM	BEIGE/BEIGE	GM	496 110i	50

ER T2E

Width/Largeur 6mm
324 200i BEIGE/BEIGE

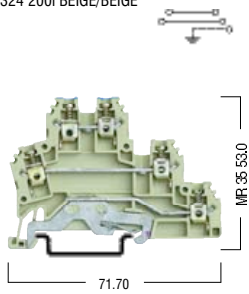

ER T3E

Width/Largeur 6mm
324 300i BEIGE/BEIGE

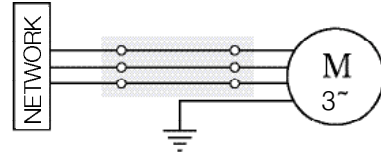
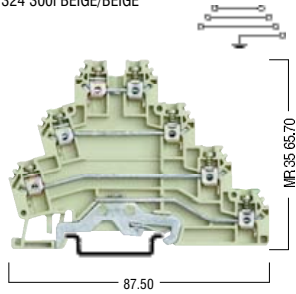

500V~/24A/2.5mm ²	500V~/24A/2.5mm ²		
440V~/24A/2.5mm ²	440V~/24A/2.5mm ²		
300V~/24A/24...12AWG	300V~/24A/24...12AWG		
9mm	9mm		
0.5-4mm ²	0.5-4mm ²		
1.5-2.5mm ²	1.5-2.5mm ²		
26.....12	26.....12		
Cat.No/No.Cat	Qty/Qt.	Cat.No/No.Cat	Qty/Qt.
324 200i	25	324 300i	25

Type/Genre	1m	Type/Genre	1m		
DINRAIL1M-SLOT	1m	DINRAIL1M-SLOT	1m		
DINRAIL1M-UNSLLOT	1m	DINRAIL1M-UNSLLOT	1m		
TS35x7.5 DINRAIL	2m	TS35x7.5 DINRAIL	2m		
DINRAIL2M-UNSLLOT	2m	DINRAIL2M-UNSLLOT	2m		
Type/Genre	Cat.No/No.Cat	Qty/Qt.	Type/Genre	Cat.No/No.Cat	Qty/Qt.
ES3	495 030i	100	ES3	495 030i	100
ES1	495 040i	100	ES1	495 040i	100

EP T2E	450 140i	10	EP T3E	450 150i	10
SP1	467 910i	100	SP1	467 910i	100

CC 2.5/2T	480 132i	25	CC 2.5/2T	480 132i	25
CC 2.5/3T	480 133i	20	CC 2.5/3T	480 133i	20
CC 2.5/4T	480 134i	15	CC 2.5/4T	480 134i	15
CC 2.5/10T	480 139i	5	CC 2.5/10T	480 139i	5
TF (Ø2.3)	493 023i	5	TF (Ø2.3)	493 023i	5
TSK 3 (Ø2.3)	490 030i	5	TSK 3 (Ø2.3)	490 030i	5

GM	496 110i	50	GM	496 110i	50
----	----------	----	----	----------	----

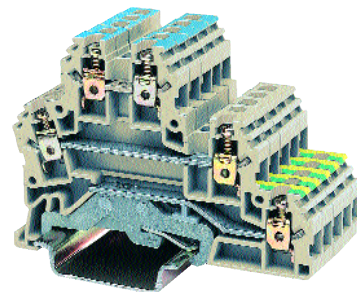
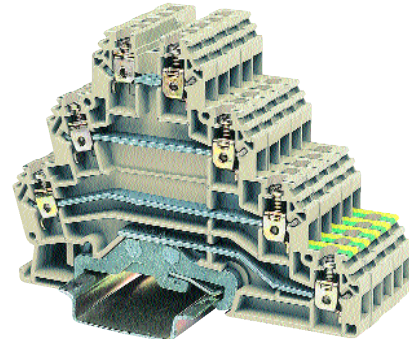
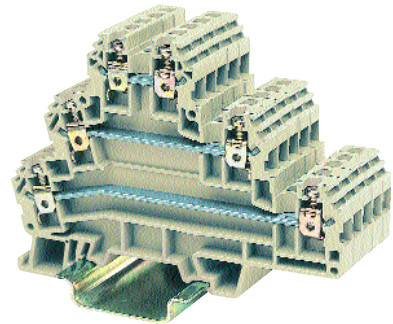

ERT 3S Series

Three Level Sensor Terminals Bornes à Trois Niveaux pour Détecteurs









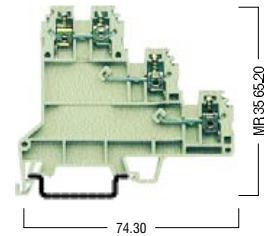

In the field of machine constructions, inductive or capacitive proximity switches are increasingly used for actuation without physical contact. In general they are designed as "Three Wire Sensors". The positive and negative conductor transmits the switching pulses ERT 3S terminal blocks minimise wiring time and costs and cabinet space when terminating three wire devices such as sensors, proximity switches etc.

On utilise de plus en plus de détecteurs sans contact sur les machines automatiques tels que: détecteurs photoélectrique, inductifs, capacitifs. Généralement ils utilisent une technologie 3 fils. L'impulsion de commutation est transmise par les conducteurs positifs et négatifs. L'utilisation des bornes ERT 3S permet de réduire le temps de câblage, le coût et l'espace occupée dans les armoires.

ERT3 S

Width/Largeur 6mm
324 400i BEIGE/BEIGE



Electrical ratings/Puissance nominale électrique				
Voltage/Current/Cross section /Tension /Courant /Section nominale	500V~/~24A/2.5mm ²			
VDE/VDE (IEC 60947-7-1)				
UL/UL				
Insulation stripping length/Longueur de dénudement	9mm			
Connection Data/Caractéristiques des connexions				
Solid Strand, Screw Connection/Fil rigide, connexion à vis	0.5-4mm ²			
Fine Strand, Screw Connection/Fil fin, connexion à vis	1.5-2.5mm ²			
AWG Conductor/Conducteur AWG	26.....12			
Ordering Data/Références		Cat.No/No.Cat	Qty/Qt.	
Polyamide 6.6.		324 400i	20	
Mounting Rails/Rails de montage		Type/Genre		
MR 35 x 7.5		DINRAIL1M-SLOT	1m	
MR 35 x 7.5 Slotted/Encoche		DINRAIL1M-UNSLLOT	1m	
Unslotted/Sans encoche	DIN EN 50022	TS35x7.5 DINRAIL	2m	
		DINRAIL2M-UNSLLOT	2m	
End Bracket/Capot d'extrémité		Type/Genre	Cat.No/No.Cat	Qty/Qt.
	For/Pour MR 35 & MR 35 BEIGE/BEIGE	ES3	495 030i	100
ES1		ES1	495 040i	100
End Plate/Partition/Plaque d'extrémité		Type/Genre	Cat.No/No.Cat	Qty/Qt.
	EPT3S	BEIGE/BEIGE Polyamide 6.6 Thickness/Epaisseur 1.5mm	EPT3 S	450 160i
				10
Small Partition/Petite séparation		Type/Genre	Cat.No/No.Cat	Qty/Qt.
	SP1	BEIGE/BEIGE	SP1	467 910i
				100
Cross Connection/Barrettes de jonction		Type/Genre	Cat.No/No.Cat	Qty/Qt.
		CC 2.5/2 T	480 132i	25
		CC 2.5/3 T	480 133i	25
		CC 2.5/4 T	480 134i	25
		CC 2.5/10 T	480 139i	25
Test Plug-Soc/Pointes de test		Type/Genre	Cat.No/No.Cat	Qty/Qt.
		TF (Ø2.3)	493 023i	5
		TSK (Ø2.3)	490 030i	5
Group Marking/Marquage de groupe		Type/Genre	Cat.No/No.Cat	Qty/Qt.
	GM	BEIGE/BEIGE	GM	496 110i
				50

ERT3 SLD

Width/Largeur 6mm
324 410i BEIGE/BEIGE

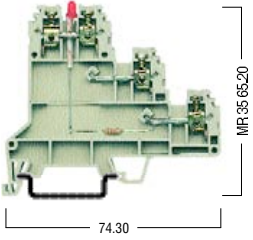

ERT3 SLD

Width/Largeur 6mm
324 420i BEIGE/BEIGE

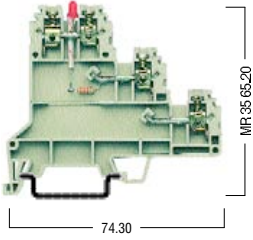

500V~/~24A/2.5mm ²	500V~/~24A/2.5mm ²
9mm	9mm
0.5-4mm ²	0.5-4mm ²
1.5-2.5mm ²	1.5-2.5mm ²
26.....12	26.....12
Cat.No/No.Cat Qty/Qt.	Cat.No/No.Cat Qty/Qt.
324 410i (24 VDC) 20	324 420i (24 VDC) 20

Type/Genre	Qty/Qt.	Type/Genre	Qty/Qt.
DINRAIL1M-SLOT	1m	DINRAIL1M-SLOT	1m
DINRAIL1M-UNSLLOT	1m	DINRAIL1M-UNSLLOT	1m
TS35x7.5 DINRAIL	2m	TS35x7.5 DINRAIL	2m
DINRAIL2M-UNSLLOT	2m	DINRAIL2M-UNSLLOT	2m

Type/Genre	Cat.No/No.Cat	Qty/Qt.	Type/Genre	Cat.No/No.Cat	Qty/Qt.
ES3	495 030i	100	ES3	495 030i	100
ES1	495 040i	100	ES1	495 040i	100

EPT3 S	450 160i	10	EPT3	450 160i	10
SP1	467 910i	100	SP1	467 910i	100

TF (Ø2.3)	493 023i	5	TF (Ø2.3)	493 023i	5
TSK (Ø2.3)	490 030i	5	TSK (Ø2.3)	490 030i	5

GM	496 110i	50	GM	496 110i	50
----	----------	----	----	----------	----

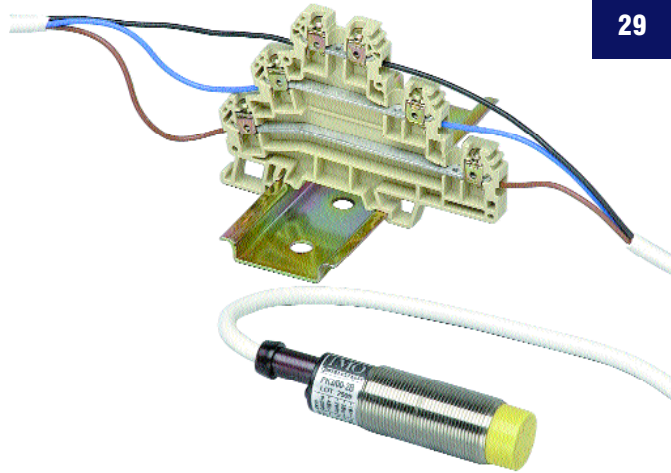
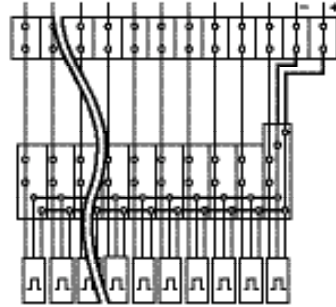

ERTD Series

Disconnect Terminals

Bornes Déconnectables

ERTD4

Width/Largeur 6mm
353 100i BEIGE/BEIGE

Disconnect terminals allow open circuit without disconnecting the conductors by a disconnect busbar. In the disconnecter, the disconnect busbar can be changed with a proper fuse to use as a fuse terminal. In ERTD 4 terminals, disconnection is achieved by lifting the knife contact to provide clear functional advantage for devices having utility instruments and associated transformers.

Les bornes déconnectables permettent d'ouvrir le circuit sans déconnecter les câbles par l'action d'une bascule. La bascule peut être remplacée par un fusible et cette borne peut donc être utilisée comme borne fusible. Dans les bornes ERTD 4 la déconnexion se fait grâce à un contact « couteau », ce qui procure une coupure franche utile lors de l'utilisation de certains instruments.

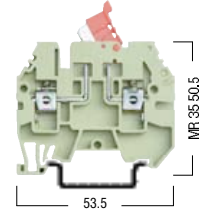

Electrical ratings/Puissance nominale électrique				
Voltage/Current/Cross section /Tension /Courant /Section nominale	500V~/24A/4mm ²			
UL/UL	600V~/16A/AWG 26-10			
Insulation stripping length/Longueur de dénudement	10mm			
Connection Data/Caractéristiques des connexions				
Solid Strand, Screw Connection/Fil rigide, connexion à vis	0.5...6mm ²			
Fine Strand, Screw Connection/Fil fin, connexion à vis	1.5...4mm ²			
AWG Conductor/Conducteur AWG	26.....10			
Ordering Data/Références		Type/Genre	Cat.No/No.Cat	Qty/Qt.
Polyamide 6.6		ERTD 4	353 100i	20
Mounting Rails/Rails de montage		Type/Genre		
 DIN EN 50035 DIN EN 50022	MR 32	DINRAIL1M-SLOT		1m
	MR 35 x 7.5 MR 35 x 7.5 Slotted/Encoche Unslotted/Sans encoche	DINRAIL1M-UNSLOT		1m
		TS35x7.5 DINRAIL		2m
		DINRAIL2M-UNSLOT		2m
End Bracket/Capot d'extrémité		Type/Genre	Cat.No/No.Cat	Qty/Qt.
 ES1	For/Pour MR 35 & MR 35 BEIGE/BEIGE	ES3	495 030i	100
	For/Pour MR 35 BEIGE/BEIGE	ES1	495 040i	100
End Plate/Partition/Plaquette d'extrémité		Type/Genre	Cat.No/No.Cat	Qty/Qt.
 EPF3	Thickness/Epaisseur 1.5mm Polyamide 6.6	EPF 3	450 050i	10
	EPERDF4			
Cross-Connection/Barrettes de jonction				
	CCS 4/2	476 232i		25
	CCS 4/3	476 233i		20
	CCS 4/4	476 234i		15
	CCS 4/10	476 239i		5
Group Marking/Marquage de groupe		Type/Genre	Cat.No/No.Cat	Qty/Qt.
	GM BEIGE/BEIGE	GM	496 110i	50

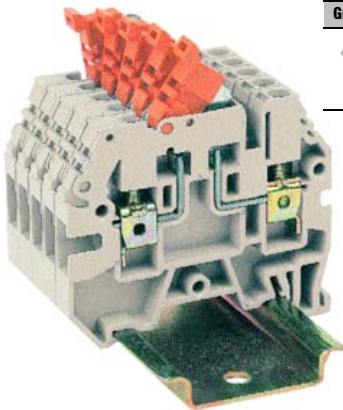

ERTD3

Width/Largeur 6mm
362 000i BEIGE/BEIGE

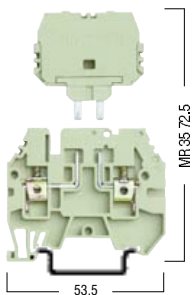

ERTD3M

Width/Largeur 6mm
363 000i BEIGE/BEIGE

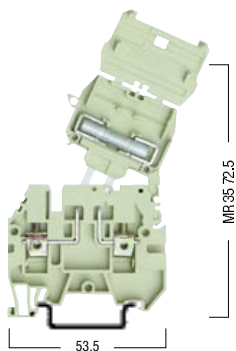

ERTD2

Width/Largeur 6mm
360 110i BEIGE/BEIGE

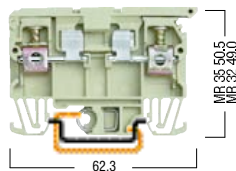

ERD4F

Width/Largeur 8mm
353 300i BEIGE/BEIGE

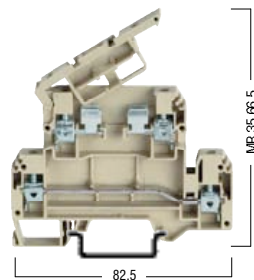

ERTD 3				ERTD 3M				ERTD 2				ERD4F			
Type/Genre	Cat.No/No.Cat	Qty/Qt.		Type/Genre	Cat.No/No.Cat	Qty/Qt.		Type/Genre	Cat.No/No.Cat	Qty/Qt.		Type/Genre	Cat.No/No.Cat	Qty/Qt.	
500V~/24A/4mm ²				500V~/24A/4mm ²				500V~/24A/4mm ²				750V~/32A/4mm ²			
600V~/10A/AWG 26-10				600V~/10A/AWG 26-10				300V~/6.3A/AWG 26-8							
10mm				10mm				12mm				9mm			
0.5...6mm ²				0.5...6mm ²				0.5...10mm ²				0.5...6mm ²			
1.5...4mm ²				1.5...4mm ²				1.5...10mm ²				1.5...4mm ²			
26.....10				26.....10				26.....8				24.....10			
Type/Genre	Cat.No/No.Cat	Qty/Qt.		Type/Genre	Cat.No/No.Cat	Qty/Qt.		Type/Genre	Cat.No/No.Cat	Qty/Qt.		Type/Genre	Cat.No/No.Cat	Qty/Qt.	
ERTD 3	362 000i	20		ERTD 3M	363 000i	20		ERTD 2	360 110i	20		ERD4F	353 300i	50	
Type/Genre				Type/Genre				Type/Genre				Type/Genre			
DINRAIL1M-SLOT		1m		DINRAIL1M-SLOT		1m		DINRAIL1M-SLOT		1m		DINRAIL1M-SLOT		1m	
DINRAIL1M-UNSLLOT		1m		DINRAIL1M-UNSLLOT		1m		DINRAIL1M-UNSLLOT		1m		DINRAIL1M-UNSLLOT		1m	
TS35x7.5 DINRAIL		2m		TS35x7.5 DINRAIL		2m		TS35x7.5 DINRAIL		2m		TS35x7.5 DINRAIL		2m	
DINRAIL2M-UNSLLOT		2m		DINRAIL2M-UNSLLOT		2m		DINRAIL2M-UNSLLOT		2m		DINRAIL2M-UNSLLOT		2m	
Type/Genre	Cat.No/No.Cat	Qty/Qt.		Type/Genre	Cat.No/No.Cat	Qty/Qt.		Type/Genre	Cat.No/No.Cat	Qty/Qt.		Type/Genre	Cat.No/No.Cat	Qty/Qt.	
ES3	495 030i	100		ES3	495 030i	100		ES3	495 030i	100		ES3	495 030i	100	
ES1	495 040i	100		ES1	495 040i	100		ES1	495 040i	100		ES1	495 040i	100	
Type/Genre				Type/Genre				Type/Genre				Type/Genre			
EPF 3	450 050i	10		EPF 3	450 050i	10		EPF 2	450 040i	10		EPERD4F	450 200i	10	
Type/Genre				Type/Genre				Type/Genre				Type/Genre			
CCS 4/2	476 232i	25		CCS 4/2	476 232i	25						CCS 6/2	476 242i	25	
CCS 4/3	476 233i	20		CCS 4/3	476 233i	20						CCS 6/3	476 243i	20	
CCS 4/4	476 234i	15		CCS 4/4	476 234i	15						CCS 6/4	476 244i	15	
CCS 4/10	476 239i	5		CCS 4/10	476 239i	5						CCS 6/10	476 249i	5	
Type/Genre				Type/Genre				Type/Genre				Type/Genre			
GM	496 110i	50		GM	496 110i	50		GM	496 110i	50		GM	496 110i	50	

ERF Series

Fuse Terminals Bornes Porte-Fusibles

Certain electrical and control systems require protection by fuses. IMO offers fuse terminals with built in safety fuse links. The terminal has a moving type hinged carrier that has a specially designed space for cartridge type glass fuse of size Ø5x20 or Ø5x25 together with a spare one. The fuse can be engaged or disengaged by the movement or the replacement of the carrier in ERF 3M and ERF3 type products respectively. Marking/identification by marking tags is possible on both terminal and fuse carrier. A specially designed built-in circuit gives light indication in event of fuse blow out.

Certains systèmes électriques nécessitent une protection par fusible. IMO propose des bornes avec un fusible de sécurité incorporé. La borne a un porte-fusible mobile monté sur charnière, spécialement conçu pour porter une cartouche de fusible en verre taille Ø5x20 ou Ø5x25 et un fusible de rechange. Le fusible peut être enclenché ou désenclenché soit par déconnexion du porte fusible (série ERF3) soit par basculement (série ERF 3M).

L'identification est possible sur le porte-fusible ou sur la borne. En cas de défaillance du fusible une LED s'allume.





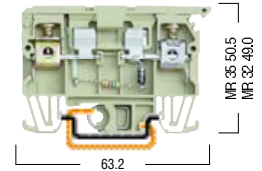
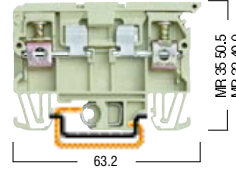

ERF2

Width/Largeur 8mm
351 100i BEIGE/BEIGE

ERF2 LD

Width/Largeur 8mm



Electrical ratings/Puissance nominale électrique							
Voltage/Current/Cross section /Tension/Courant/Section nominale	500V~/6.3A/6mm ²			-V~/6.3A/6mm ²			
UL/UL	300V~/6.3A/AWG 26-8			-V~/6.3A/AWG 26-8			
Insulation stripping length/Longueur de dénudement	12mm			12mm			
Connection Data/Caractéristiques des connexions							
Solid Strand, Screw Connection/Fil rigide, connexion à vis	0.5...10mm ²			0.5...10mm ²			
Fine Strand, Screw Connection/Fil fin, connexion à vis	1.5...10mm ²			1.5...10mm ²			
AWG Conductor/Conducteur AWG	26...8			26...8			
Ordering Data/Références		Type/Genre	Cat.No/No.Cat	Qty/Qt.	Type/Genre	Cat.No/No.Cat	Qty/Qt.
Polyamide 6.6	BEIGE/BEIGE	ERF 2	351 100i	50	ERF 2LD	351 210i (24V AC)	25
					ERF 2LD	351 220i (24V DC)	25
					ERF 2LD	351 310i (48V AC)	25
					ERF 2LD	351 320i (44V DC)	25
					ERF 2LD	351 510i (110V AC)	25
					ERF 2LD	351 520i (110V DC)	25
					ERF 2LD	351 610i (220V AC)	25
			ERF 2LD	351 620i (220V DC)	25		
Mounting Rails/Rails de montage		Type/Genre			Type/Genre		
 MR 32 DIN EN 50035	MR 35 x 7.5 MR 35 x 7.5 Slotted/Encoche Unslotted/Sans encoche  DIN EN 50022	DINRAIL1M-SLOT	1m		DINRAIL1M-SLOT	1m	
		DINRAIL1M-UNSLLOT	1m		DINRAIL1M-UNSLLOT	1m	
		TS35x7.5 DINRAIL	2m		TS35x7.5 DINRAIL	2m	
		DINRAIL1M-UNSLLOT	2m		DINRAIL2M-UNSLLOT	2m	
		MR 32	1m		MR 32	1m	
End Bracket/Capot d'extrémité		Type/Genre	Cat.No/No.Cat	Qty/Qt.	Type/Genre	Cat.No/No.Cat	Qty/Qt.
 ES1	For/Pour MR 35 & MR 35 BEIGE/BEIGE	ES3	495 030i	100	ES3	495 030i	100
	For/Pour MR 35 BEIGE/BEIGE	ES1	495 040i	100	ES1	495 040i	100
End Plate/Partition/Plaque d'extrémité		Type/Genre	Cat.No/No.Cat	Qty/Qt.	Type/Genre	Cat.No/No.Cat	Qty/Qt.
 EPF2	BEIGE/BEIGE	EPF 2	450 040i	10	EPF 2	450 040i	10
	GREY/GRIS	EPF 2	450 049i	10	EPF 2	450 049i	10
Thickness/Epaisseur 1.5mm							
Cross-Connection/Barrettes de jonction							
							
Group Marking/Marquage de groupe		Type/Genre	Cat.No/No.Cat	Qty/Qt.	Type/Genre	Cat.No/No.Cat	Qty/Qt.
	GM BEIGE/BEIGE	GM	496 110	50	GM	496 110	50
	GREY/GRIS	GEM	496 119	50	GM	496 119	50

ERF3

Width/Largeur 6mm
354 100i BEIGE/BEIGE

ERF3 LD

Width/Largeur 6mm

ERF3M

Width/Largeur 6mm
355 100i BEIGE/BEIGE

ERF3 MLD

Width/Largeur 6mm
362 000i BEIGE/BEIGE

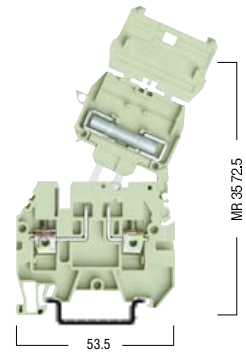
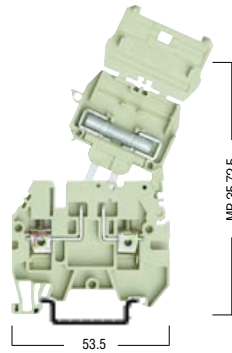
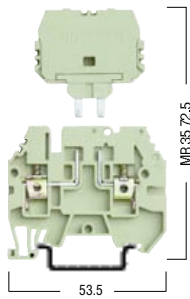
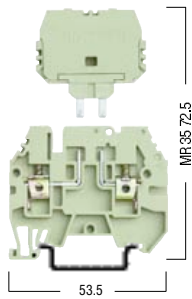

600V~/6.3A/4mm ²			-V~/6.3A/4mm ²			600V~/6.3A/4mm ²			-V~/A/4mm ²		
600V~/A/AWG26-10			-V~/10A/AWG 26-10			600V~/10A/AWG 26-10			-V~/A/AWG 26-10		
12mm			12mm			12mm			12mm		
0.5...6mm ²			0.5...6mm ²			0.5...6mm ²			0.5...6mm ²		
1.5...4mm ²			1.5...4mm ²			1.5...4mm ²			1.5...4mm ²		
26.....10			26.....10			26.....10			26.....10		
Type/Genre	Cat.No/No.Cat	Qty/Qt.	Type/Genre	Cat.No/No.Cat	Qty/Qt.	Type/Genre	Cat.No/No.Cat	Qty/Qt.	Type/Genre	Cat.No/No.Cat	Qty/Qt.
ERF 3F	354 100i	20	ERF 3LD	354 210i (24 VAC)	20	ERF 3M	355 100i	20	ERF3 MLD	355 210i (24 VAC)	20
			ERF 3LD	354 220i (24 VDC)	20				ERF3 MLD	355 220i (24 VDC)	20
			ERF 3LD	354 310i (48 VAC)	20				ERF3 MLD	355 310i (48 VAC)	20
			ERF 3LD	354 320i (48 VDC)	20				ERF3 MLD	355 320i (48 VDC)	20
			ERF 3LD	354 510i (110 VAC)	20				ERF3 MLD	355 510i (110 VAC)	20
			ERF 3LD	354 520i (110 VDC)	20				ERF3 MLD	355 520i (110 VDC)	20
			ERF 3LD	354 610i (220 VAC)	20				ERF3 MLD	355 610i (220 VAC)	20
			ERF 3LD	354 620i (220 VDC)	20				ERF3 MLD	355 620i (220 VDC)	20
Type/Genre	Cat.No/No.Cat	Qty/Qt.	Type/Genre	Cat.No/No.Cat	Qty/Qt.	Type/Genre	Cat.No/No.Cat	Qty/Qt.	Type/Genre	Cat.No/No.Cat	Qty/Qt.
DINRAIL1M-SLOT		1m	DINRAIL1M-SLOT		1m	DINRAIL1M-SLOT		1m	DINRAIL1M-SLOT		1m
DINRAIL1M-UNSLOT		1m	DINRAIL1M-UNSLOT		1m	DINRAIL1M-UNSLOT		1m	DINRAIL1M-UNSLOT		1m
TS35x7.5 DINRAIL		2m	TS35x7.5 DINRAIL		2m	TS35x7.5 DINRAIL		2m	TS35x7.5 DINRAIL		2m
DINRAIL2M-UNSLOT		2m	DINRAIL2M-UNSLOT		2m	DINRAIL2M-UNSLOT		2m	DINRAIL2M-UNSLOT		2m
Type/Genre	Cat.No/No.Cat	Qty/Qt.	Type/Genre	Cat.No/No.Cat	Qty/Qt.	Type/Genre	Cat.No/No.Cat	Qty/Qt.	Type/Genre	Cat.No/No.Cat	Qty/Qt.
ES3	495 030i	100	ES3	495 030i	100	ES3	495 030i	100	ES3	495 030i	100
ES1	495 040i	100	ES1	495 040i	100	ES1	495 040i	100	ES1	495 040i	100
Type/Genre	Cat.No/No.Cat	Qty/Qt.	Type/Genre	Cat.No/No.Cat	Qty/Qt.	Type/Genre	Cat.No/No.Cat	Qty/Qt.	Type/Genre	Cat.No/No.Cat	Qty/Qt.
EPF 3	450 050i	10	EPF 3	450 050i	10	EPF 3	450 050i	10	EPF 3	450 050i	10
Type/Genre	Cat.No/No.Cat	Qty/Qt.	Type/Genre	Cat.No/No.Cat	Qty/Qt.	Type/Genre	Cat.No/No.Cat	Qty/Qt.	Type/Genre	Cat.No/No.Cat	Qty/Qt.
CCS 4/2	476 232i	25	CCS 4/2	476 232i	25	CCS 4/2	476 232i	25	CCS 4/2	476 232i	25
CCS 4/3	476 233i	20	CCS 4/3	476 233i	20	CCS 4/3	476 233i	20	CCS 4/3	476 233i	20
CCS 4/4	476 234i	15	CCS 4/4	476 234i	15	CCS 4/4	476 234i	15	CCS 4/4	476 234i	15
CCS 4/10	476 239i	5	CCS 4/10	476 239i	5	CCS 4/10	476 239i	5	CCS 4/10	476 239i	5
Type/Genre	Cat.No/No.Cat	Qty/Qt.	Type/Genre	Cat.No/No.Cat	Qty/Qt.	Type/Genre	Cat.No/No.Cat	Qty/Qt.	Type/Genre	Cat.No/No.Cat	Qty/Qt.
GM	496 110i	50	GM	496 110i	50	GM	496 110i	50	GM	496 110i	50

ERF4 Series

Fuse Terminals for American Standards Bornes Porte-Fusibles pour Standards Américains

IMO Fuse terminals are designed to be used with 6.35mm x 31.75mm (1/4 x 1 1/4 inch) fuses and busbars as an American standard.

Les bornes porte-fusibles IMO sont conçues pour être utilisées avec des fusibles de 6,35 x 31,75 mm (1/4" x 1 1/4") et des barres de distribution répondant au standard américain.

ERF4



Width/Largeur 8mm
351 120i BEIGE/BEIGE

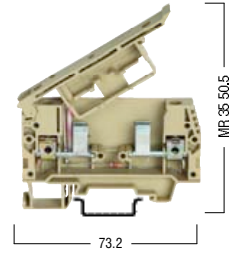

ERF4 LD

Width/Largeur 8mm



Electrical ratings/Puissance nominale électrique							
Voltage/Current/Cross section /Tension /Courant/Section nominale	750V~/10A/8mm ²			750V~/10A/6mm ²			
UL/cUL							
Insulation stripping length/Longueur de dénudement	12mm			12mm			
Connection Data/Caractéristiques des connexions							
Solid Strand, Screw Connection/Fil rigide, connexion à vis	0.5.....10mm ²			0.5.....10mm ²			
Fine Strand, Screw Connection/Fil fin, connexion à vis	1.5.....6mm ²			1.5.....6mm ²			
AWG Conductor/Conducteur AWG	22.....8			22.....8			
Ordering Data/Références							
Polyamide 6.6	BEIGE/BEIGE	ERF 4	351 120i	20	ERF 4LD	351 710i (24 VDC)	25
					ERF 4LD	351 720i (24 VDC)	25
					ERF 4LD	351 730i (48 VDC)	25
					ERF 4LD	351 740i (44 VDC)	25
					ERF 4LD	351 750i (110 VAC)	25
					ERF 4LD	351 760i (110 VDC)	25
					ERF 4LD	351 770i (220 VAC)	25
					ERF 4LD	351 780i (220 VDC)	25
Mounting Rails/Rails de montage							
MR 35 x 7.5		Type/Genre			Type/Genre		
MR 35 x 7.5		DINRAIL1M-SLOT	1m		DINRAIL1M-SLOT	1m	
Slotted/Encoche		DINRAIL1M-UNSLLOT	1m		DINRAIL1M-UNSLLOT	1m	
Unslotted/Sans encoche	DIN EN 50022	TS35x7.5 DINRAIL	2m		TS35x7.5 DINRAIL	2m	
		DINRAIL1M-UNSLLOT	2m		DINRAIL1M-UNSLLOT	2m	
End Bracket/Capot d'extrémité							
		Type/Genre	Cat.No/No.Cat	Qty/Qt.	Type/Genre	Cat.No/No.Cat	Qty/Qt.
	For/Pour MR 35 & MR 35 BEIGE/BEIGE	ES3	495 030i	100	ES3	495 030i	100
ES1	For/Pour MR 35 BEIGE/BEIGE	ES1	495 040i	100	ES1	495 040i	100
Group Marking/Marquage de groupe							
		GM	496 110i	50	GM	496 110i	50
	GM BEIGE/BEIGE	GM	496 119i	50	GM	496 119i	50
	GREY/GRIS	GM	496 119i	50	GM	496 119i	50

Notes

ERWT Series

Test/Disconnect Terminals Bornes de Test

ERWT type test/disconnect terminals are made of thermoplastic material. Both terminals operate in bolt disconnection system. These terminals are usually used in measurement and test connections. They're designed for quick solutions by test plugs and cross-connections.

Les bornes de test série ERWT sont fabriquées en matériau thermoplastique. Le système de connexion est verrouillable et déverrouillable. Elles sont généralement utilisées pour les tests et les mesures. Leur conception permet d'économiser du temps grâce aux prises de tests et l'interconnexion.

ERWT1

Width/Largeur 8mm

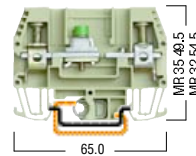

ERWT2

Width/Largeur 6mm

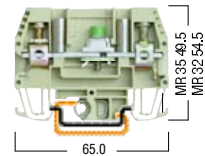

Electrical ratings/Puissance nominale électrique								
Voltage/Current/Cross section/Tension /Courant /Section nominale		380V~ /44A /6mm ²		380V~ /61A /10mm ²				
VDE/VDE				400V~ /57A /10mm ²				
UL/UL				600V~ /50A /AWG 16-8				
Insulation stripping length/Longueur de dénudement		12mm		12mm				
Connection Data/Caractéristiques des connexions								
Solid Strand, Screw Connection/Fil rigide, connexion à vis		0.5.....10mm ²		0.5.....16mm ²				
Fine Strand, Screw Connection/Fil fin, connexion à vis		1.5.....6mm ²		1.5.....10mm ²				
AWG Conductor/Conducteur AWG		20.....8		16.....8				
Ordering Data/Références		FOR/POUR GREY/GRIS:37..9.	Type/Genre	Cat.No/No.Cat	Qty/Qt.	Type/Genre	Cat.No/No.Cat	Qty/Qt.
Without Test Socket/Sans prise d'essais	Polyamide 6.6	BEIGE/BEIGE	ERWTO	370 500i	20	ERWTO	385 500i	20
Test Socket/Prise d'essais		BEIGE/BEIGE	ERWT1	370 501i	20	ERWT1	385 501i	20
Double Test Socket/Prise d'essais double		BEIGE/BEIGE	ERWT2	370 502i	20	ERWT2	385 502i	20
Mounting Rails/Rails de montage		Type/Genre			Type/Genre			
MR 32	MR 35 x 7.5		DINRAIL1M-SLOT	1m		DINRAIL1M-SLOT	1m	
	MR 35 x 7.5		DINRAIL1M-UNSLLOT	1m		DINRAIL1M-UNSLLOT	1m	
	Slotted/Encoche	Unslotted/Sans encoche	TS35x7.5 DINRAIL	2m		TS35x7.5 DINRAIL	2m	
			DINRAIL2M-UNSLLOT	2m		DINRAIL2M-UNSLLOT	2m	
			MR 32	1m		MR 32	1m	
End Bracket/Capot d'extrémité		Type/Genre			Type/Genre			
Thickness/Epaisseur 8mm	For/Pour MR 35 & MR 35	BEIGE/BEIGE	ES3	495 030i	100	ES3	495 030i	100
	For/Pour MR 35	BEIGE/BEIGE	ES1	495 040i	100	ES1	495 040i	100
End Plate/Pa rition/Plaque de extrémité		Type/Genre			Type/Genre			
Thickness/Epaisseur 1.5mm		BEIGE/BEIGE	EPWT	450 120i	5	EPWT	450 120i	5
		GREY/GRIS						
Small Partition/Petite séparation		Type/Genre			Type/Genre			
		BEIGE/BEIGE	SP2	467 950i	100	SP2	467 950i	100
Cross-Connection/Barrettes de jonction		Type/Genre			Type/Genre			
			CC 6/2W	480 182i	10	CC 10/2W	480 172i	10
			CC 6/3W	480 182i	10	CC 10/3W	480 173i	10
			CC 6/4W	480 182i	10	CC 10/4W	480 174i	10
			CC 6/10W	480 182i	5	CC 10/10W	480 176i	10
						CC10/10W	480 179i	5
Switchable Cross-Con.Links/Interconnexion commutable		Type/Genre			Type/Genre			
			SL1	485 506i	10	SL2	485 510i	10
Test Plug-Soc/Pointes de test		Type/Genre			Type/Genre			
			ITK 32	492 020i	5	ITK 32	492 020i	5
			TSK 6	490 060i	5	TSK 6	490 060i	5
						TF 4	493 040i	5
Group Marking/Marquage de groupe		Type/Genre			Type/Genre			
		GM	GM	496 110i	50	GM	496 110	50

ERDT Series

Distribution Terminals

Bornes de Distribution

ERDT 10/16

Width/Largeur 11mm
395 100i

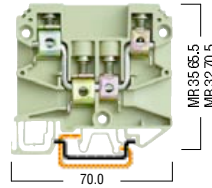

ERDT 10/16

Width/Largeur 2, 3, 4, 5mm
(With End Plate/Plaquelette d'extrémité)



Distribution Terminals:

IMO offers you ERDT Distribution terminals to prevent connection difficulties inside the lighting poles. As the cable connection is done via one inside cross-connection, ERDT terminals can be used as distribution terminal in electric panels.

Connection: ERDT terminals have four input connections on an inside cross-connection; two 16mm² section one side and two 10mm² section on the other. It is possible to connect two cables, one coming from ground to pole, the other from pole to pole, to the terminal without bending the cables.



Input connections on the other side of the terminal, can be used in armature connection via fuse. Since lighting poles have three phase system. ERDT terminals are produced as single mountable, single non-mountable terminals and double, triple, quartet and fivefold blocks. In a lighting pole, three phase + neutral connection is done by a quarter block and an automatic fuse.

Bornes de Distribution:

IMO propose des bornes de distribution destinées à prévenir des difficultés de câblage à l'intérieur des lampadaires publics. Comme le câblage des fils est fait sur une interconnexion interne, la borne ERDT peut être utilisée comme une borne d'alimentation électrique.

Connexions: Les bornes ERDT ont quatre entrées du côté interconnexion, deux d'une section de 16 mm² d'un côté et deux de 10 mm² de l'autre. Il est possible de brancher deux fils sur la borne sans les plier, l'un de la terre à un pôle, l'autre d'un pôle vers l'autre. Les entrées de l'autre côté de la borne peuvent être utilisées comme terre via le fusible. Comme les lampadaires sont alimentés en trois phases les bornes ERDT sont proposées en version simple montable, simple non-montable, double, triple, quadruple ou quintuple. Dans un lampadaire alimenté en trois phases + neutre la connexion est faite en utilisant un bloc quadruple avec fusible automatique.

Electrical ratings/Puissance nominale électrique			
Voltage/Current/Cross section/Tension/Courant/Section nominale	750V~ / (61/82A) / (10/16mm ²)		750V~ / (61/82A) / (10/16mm ²)
Insulation stripping length/Longueur de dénudement	18 / 18mm		18 / 18mm
Connection Data/Caractéristiques des connexions			
Solid Strand, Screw Connection/Fil rigide, connexion à vis	1.5.....16mm ² / 1.5.....16mm ²		1.5.....16mm ² / 1.5.....16mm ²
Fine Strand, Screw Connection/Fil fin, connexion à vis	1.5.....16mm ² / 1.5.....25mm ²		1.5.....16mm ² / 1.5.....25mm ²
AWG Conductor/Conducteur AWG	16.....8/14.....6		16.....8/14.....6
Ordering Data/Références			
	Type/Genre	Cat.No/No.Cat	Qty/Qt.
Polyamide 6.6	BEIGE/BEIGE	ERDT 10/16	395 100i
			20
		ERDT 10/16-2	395 220i
		ERDT 10/16-3	395 230i
		ERDT 10/16-4	395 240i
		ERDT 10/16-5	395 250i

Mounting Rails/Rails de montage		Type/Genre	Type/Genre
		DINRAIL1M-SLOT	1m
		DINRAIL1M-UNSLLOT	1m
		TS35x7.5 DINRAIL	2m
		DINRAIL2M-UNSLLOT	2m
		MR 32	1m
MR 32	MR 35 x 7.5 MR 35 x 7.5 Slotted/Encoche Unslotted/Sans encoche		
			
DIN EN 50035	DIN EN 50022		

End Bracket/Capot d'extrémité			
Thickness/Epaisseur 8mm	For/Pour MR 35 & MR 35	BEIGE/BEIGE	
	ES3	495 030i	100
	ES1	495 040i	100
		ES3	495 030i
		ES1	495 040i

End Plate/Partition/Plaquelette d'extrémité			
Thickness/Epaisseur	BEIGE/BEIGE	EPDT	450 090i
			10

Group Marking/Marquage de groupe			
	GM	BEIGE/BEIGE GREY/GRIS	
	GM	496 110i	50
		GM	496 110i
			50

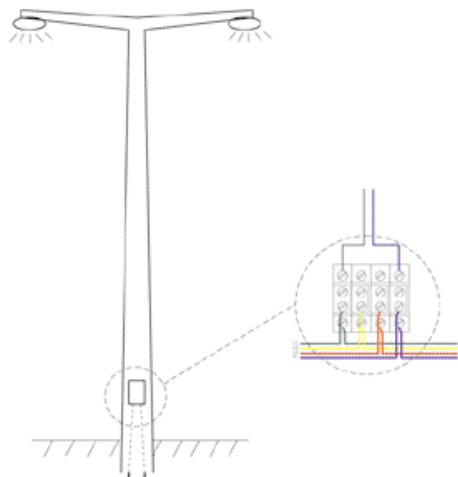

SC Series

Spring Clamp Terminals Bornes à Ressort

SC 2.5

Width/Largeur 5mm
306 220i BEIGE/BEIGE

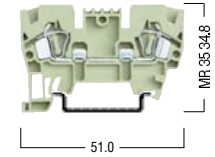









Spring clamp terminals provide a realistic alternative to terminal blocks with screw clamp connection in many fields of application.

The spring clamp is operated by using a screw driver to provide an access to wire through the opening in the spring clamp.

The wire end gets clamped onto the current bar on removal of screw driver. SC type spring clamp terminals decrease the mounting and revision costs relative to screw type terminals. Interlocking mechanism on the plastic housing prevents terminal blocks being separated from each other when the cables are connected.

Les bornes à ressort fournissent une bonne alternative aux bornes à vis dans la plupart des applications. On utilise un tournevis pour créer une ouverture dans la pince ce qui permet de passer le fil. L'extrémité du fil est pincée lorsque l'on retire le tournevis.

Ce type de borne permet une économie de temps substantielle dans le câblage par rapport aux systèmes à vis. Un mécanisme de verrouillage sur le boîtier plastique permet aux blocs de jonction d'être séparés les uns des autres lorsqu'ils sont câblés.

Electrical ratings/Puissance nominale électrique						
Voltage/Current/Cross section /Tension /Courant /Section nominale	750V~/22A/2.5mm ²					
UL/UL	600V~/20A /AWG 22-12					
Insulation stripping length/Longueur de dénudement	10mm					
Connection Data/Caractéristiques des connexions						
Solid Strand, Clamp Connection/Fil rigide, Connexion à ressort	0.5-2.5mm ²					
Fine Strand, Clamp Connection/Fil fin, Connexion à ressort	0.5-2.5mm ²					
AWG Conductor/Conducteur AWG	22.....12					
Ordering Data/Références			Cat.No/No.Cat	Qty/Qt.		
Polyamide 6.6.			BEIGE/BEIGE	306 220i	100	
Mounting Rails/Rails de montage		Type/Genre				
MR 35 x 7.5		DINRAIL1M-SLOT	1m			
MR 35 x 7.5 Slotted/Encoche Unslotted/Sans encoche		DINRAIL1M-UNSLLOT	1m			
		TS35x7.5 DINRAIL	2m			
		DINRAIL2M-UNSLLOT	2m			
End Bracket/Capot d'extrémité		Type/Genre	Cat.No/No.Cat	Qty/Qt.		
	ES4	For/Pour MR 35 & MR 35 GREY/GRIS	ES 4	495 050i	100	
End Plate/Partition/Plaque d'extrémité		Thickness/Epaisseur	Type/Genre	Cat.No/No.Cat	Qty/Qt.	
		1.2mm	Polyamide 6.6. BEIGE/BEIGE	EPS 2.5	446 320i	100
			EPS			
Cross-Connection/Barrettes de jonction		Type/Genre	Cat.No/No.Cat	Qty/Qt.		
		CCS 2.5/2	476 222i	25		
		CCS 2.5/3	476 223i	20		
		CCS 2.5/4	476 224i	15		
		CCS 2.5/10	476 229i	5		
Group Marking/Marquage de groupe		Type/Genre	Cat.No/No.Cat	Qty/Qt.		
		GM BEIGE/BEIGE	GM	496 110i	50	

Colours Couleurs	Terminals Bornes	End Plate Plaque d'extrémité
	SC 2.5	EPSC
BEIGE/BEIGE	306 220i	446 320i
BLUE/BLEU	306 221i	446 321i
GREEN/VERT	306 222i	446 322i
YELLOW/JAUNE	306 223i	446 323i
RED/ROUGE	306 224i	446 324i
GREY/GRIS	306 229i	446 329i
	SC 4	EPSC
BEIGE/BEIGE	306 230i	446 330i
BLUE/BLEU	306 231i	446 331i
GREEN/VERT	306 232i	446 332i
YELLOW/JAUNE	306 233i	446 333i
RED/ROUGE	306 234i	446 334i
GREY/GRIS	306 239i	446 339i
	SC 6	EPSC
BEIGE/BEIGE	306 240i	446 340i
BLUE/BLEU	306 241i	446 341i
GREEN/VERT	306 242i	446 342i
YELLOW/JAUNE	306 243i	446 343i
RED/ROUGE	306 244i	446 344i
GREY/GRIS	306 249i	446 349i
	SC 10	EPSC
GREY/GRIS	306 250i	446 350i
BLUE/BLEU	306 251i	446 351i
GREEN/VERT	306 252i	446 352i
YELLOW/JAUNE	306 253i	446 353i
RED/ROUGE	306 254i	446 354i
BLACK/NOIR	306 259i	446 359i

SC 4

Width/Largeur 6mm
306 230i BEIGE/BEIGE

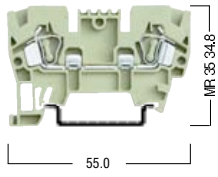

SC 6

Width/Largeur 8mm
306 240i BEIGE/BEIGE

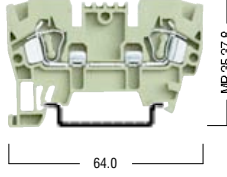

SC 10

Width/Largeur 10mm
306 250i BEIGE/BEIGE

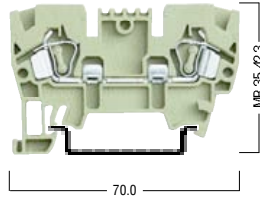

750V~/30A/4mm ²		750V~/40A/6mm ²		750V~/63A/10mm ²	
600V~/26A /AWG 22-12		600V~/35A /AWG 22-8		600V~/55A /AWG 20-6	
12mm		13mm		13mm	
0.5-4mm ²		0.5-6mm ²		0.5-10mm ²	
0.5-4mm ²		0.5-6mm ²		0.5-10mm ²	
22.....10		22.....8		20.....6	
Cat.No/No.Cat	Qty/Qt.	Cat.No/No.Cat	Qty/Qt.	Cat.No/No.Cat	Qty/Qt.
306 230i	100	306 240	100	306 250i	100
Type/Genre		Type/Genre		Type/Genre	
DINRAIL 1M-SLOT	1m	DINRAIL 1M-SLOT	1m	DINRAIL 1M-SLOT	1m
DINRAIL 1M-UNSLLOT	1m	DINRAIL 1M-UNSLLOT	1m	DINRAIL 1M-UNSLLOT	1m
TS35x7.5 DINRAIL	2m	TS35x7.5 DINRAIL	2m	TS35x7.5 DINRAIL	2m
DINRAIL 2M-UNSLLOT	2m	DINRAIL 2M-UNSLLOT	2m	DINRAIL 2M-UNSLLOT	2m
Type/Genre	Cat.No/No.Cat	Qty/Qt.	Type/Genre	Cat.No/No.Cat	Qty/Qt.
ES 4	495 050i	100	ES 4	495 050i	100
EPS 4	446 330i	100	EPS 6	446 340i	100
EPS 10	446 350i	100			
CCS 4/2	476 232i	25	CCS 6/2	476 242i	25
CCS 4/3	476 233i	20	CCS 6/3	476 243i	20
CCS 4/4	476 234i	15	CCS 6/4	476 244i	15
CCS 4/10	476 239i	5	CCS 6/10	476 249i	5
GM	496 110i	50	GM	496 110i	50

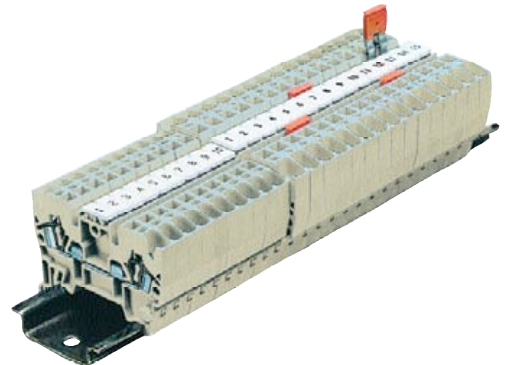

SCS Series

Terminals for PCB Connections

Bornes pour Connexion sur Circuits Imprimés







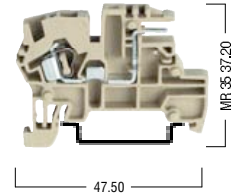

SCS terminals are designed for 2.5mm² spring clamp connection to the printed circuit board via PCB terminals. The product range consists of one input one output and one input two output terminals. Both ranges have 24 VDC, 110 VAC and 220 VAC LED indicators on request. Socket outputs enable connection of all the available PCB plug terminals having a pitch of 5.08 mm in the market. Unused socket outputs can be closed by insulation plugs to prevent finger touch. The insulation plugs can be put on and taken out easily without any hand tools. The terminals are fixed each other by the pins forming blocks and provide users to make cross connections with patented cross connection system of SC2.5 without keeping extra stock.

Les bornes à ressort SCS sont conçues pour connecter les fils de 2,5mm² via des borniers de circuit imprimé. La gamme est formée de bornes à une entrée une sortie et une entrée deux sorties. Les deux gammes peuvent être équipées de LED 24 VCC, 110 VAC et 220 VAC sur demande. Les socles de sortie permettent de connecter tous les borniers enfichables pour circuits imprimés disponibles et ayant un pas de 5,08 mm. Les socles de sortie non utilisés peuvent être bouchés grâce à des fiches isolantes de façon à éviter tout contact avec les doigts. Les bornes se fixent les unes aux autres grâce aux broches, elles forment ainsi un bloc et permettent aux utilisateurs de les interconnecter grâce au système de barrettes de connexion breveté, SC2.5, sans avoir à mettre en place un stock supplémentaire.

SCS 2.5

Width/Largeur 5.05mm
364 010i BEIGE/BEIGE



Electrical ratings/Puissance nominale électrique				
Voltage/Current/Cross section /Tension /Courant/Section nominale	250V~/10A/2.5mm ²			
Insulation stripping length/Longueur de dénudement	10mm			
Connection Data/Caractéristiques des connexions				
Solid Strand, Clamp Connection/Fil rigide, Connexion à ressort	0.5.....2.5mm ²			
Fine Strand, Clamp Connection/Fil fin, Connexion à ressort	0.5.....2.5mm ²			
AWG Conductor/Conducteur AWG	22.....12			
Ordering Data/Références			Cat.No/No.Cat	Qty/Qt.
Polyamide 6.6	BEIGE/BEIGE		364 010i	100
	BLUE/BLEU			
Mounting Rails/Rails de montage		Type/Genre		
MR 35 x 7.5		DINRAIL1M-SLOT		1m
MR 35 x 7.5 Slotted/Encoche		DINRAIL1M-UNSLLOT		1m
Unslotted/Sans encoche		TS35x7.5 DINRAIL		2m
		DINRAIL2M-UNSLLOT		2m
End Bracket/Capot d'extrémité		Type/Genre	Cat.No/No.Cat	Qty/Qt.
	ES4	BEIGE/BEIGE Thickness/Epaisseur 8 mm	ES4	495 050i
End Plate/Partition/Plaque d'extrémité		Type/Genre	Cat.No/No.Cat	Qty/Qt.
	EPSC2.5 Polyamide 6.6	BEIGE/BEIGE BLUE/BLEU Thickness/Epaisseur 1.5mm	EPSC2.5	450 190i
Insulation Plug/Fiche d'isolation		Type/Genre	Cat.No/No.Cat	Qty/Qt.
	SCS2.5 IP Polyamide 6.6	BEIGE/BEIGE BLUE/BLEU	SCS2.5 IP	50
Cross-Connection/Barrettes de jonction				
		CCS 2.5/2	476 222i	25
		CCS 2.5/3	476 223i	20
		CCS 2.5/4	476 224i	15
		CCS 2.5/10	476 229i	5
PCB Terminal Blocks/Pour circuit imprimé borniers				
		21.950m/2		
		21.950m/3		
		21.950m/4		
		21.950m/5		
		21.950m/6		
		21.950m/9		
		21.950m/12		

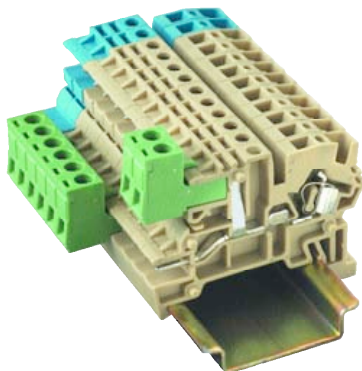

SCS 2.5E

Width/Largeur 5.05mm
364 050i BEIGE/BEIGE

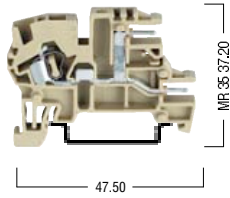

SCS 2.5L

Width/Largeur 5.05mm
--- --0 BEIGE/BEIGE

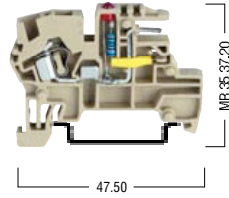

SCS 2.5EL

Width/Largeur 5.05mm
--- --0 BEIGE/BEIGE

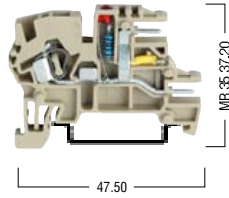

SCS 2.5N

Width/Largeur 5.05mm
364 011i BLUE/BLEU

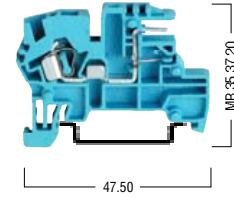

SCS 2.5E		SCS 2.5L		SCS 2.5EL		SCS 2.5N		
250V~/10A/2.5mm ²		-V~/10A/2.5mm ²		-V~/10A/2.5mm ²		250V~/10A/2.5mm ²		
10mm		10mm		10mm		10mm		
0.5.....2.5mm ²		0.5.....2.5mm ²		0.5.....2.5mm ²		0.5.....2.5mm ²		
0.5.....2.5mm ²		0.5.....2.5mm ²		0.5.....2.5mm ²		0.5.....2.5mm ²		
22.....12		22.....12		22.....12		22.....12		
Cat.No/No.Cat	Qty/Qt.	Cat.No/No.Cat	Qty/Qt.	Cat.No/No.Cat	Qty/Qt.	Cat.No/No.Cat	Qty/Qt.	
364 050i	100	364 020i (24 VDC)	50	364 060i (24 VDC)	50			
		364 030i (110 VAC)	50	364 070i (110 VAC)	50			
		364 040i (220 VAC)	50	364 080i (220 VAC)	50			
						364 011i	100	
Type/Genre		Type/Genre		Type/Genre		Type/Genre		
DINRAIL1M-SLOT	1m	DINRAIL1M-SLOT	1m	DINRAIL1M-SLOT	1m	DINRAIL1M-SLOT	1m	
DINRAIL1M-UNSLLOT	1m	DINRAIL1M-UNSLLOT	1m	DINRAIL1M-UNSLLOT	1m	DINRAIL1M-UNSLLOT	1m	
TS35x7.5 DINRAIL	2m	TS35x7.5 DINRAIL	2m	TS35x7.5 DINRAIL	2m	TS35x7.5 DINRAIL	2m	
DINRAIL2M-UNSLLOT	2m	DINRAIL2M-UNSLLOT	2m	DINRAIL2M-UNSLLOT	2m	DINRAIL2M-UNSLLOT	2m	
Type/Genre	Cat.No/No.Cat	Qty/Qt.	Type/Genre	Cat.No/No.Cat	Qty/Qt.	Type/Genre	Cat.No/No.Cat	Qty/Qt.
ES4	495 050i	100	ES4	495 050i	100	ES4	495 050i	100
EPSC2.5	450 190i	100	EPSC2.5	450 190i	100	EPSC2.5	450 190i	100
SCS2.5 IP		50	SCS2.5 IP		50	SCS2.5 IP		50
CCS 4/2	476 232i	25	CCS 4/2	476 232i	25	CCS 4/2	476 232i	25
CCS 4/3	476 233i	20	CCS 4/3	476 233i	20	CCS 4/3	476 233i	20
CCS 4/4	476 234i	15	CCS 4/4	476 234i	15	CCS 4/4	476 234i	15
CCS 4/10	476 239i	5	CCS 4/10	476 239i	5	CCS 4/10	476 239i	5
21.950m/2			21.950m/2			21.950m/2		
21.950m/3			21.950m/3			21.950m/3		
21.950m/4			21.950m/4			21.950m/4		
21.950m/5			21.950m/5			21.950m/5		
21.950m/6			21.950m/6			21.950m/6		
21.950m/9			21.950m/9			21.950m/9		
21.950m/12			21.950m/12			21.950m/12		

SCD 2.5CS

Width/Largeur 5mm
326 200i BEIGE/BEIGE

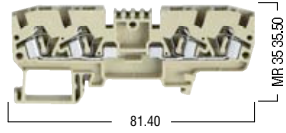

SCD 2.5CD

Width/Largeur 5mm
326 210i BEIGE/BEIGE

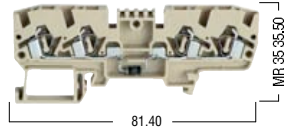

SCD 2.5CLD

Width/Largeur 5mm
326--0i BEIGE/BEIGE

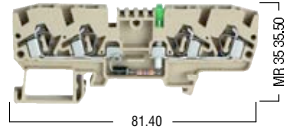

SCD 2.5PE

Width/Largeur 5mm
336 100i

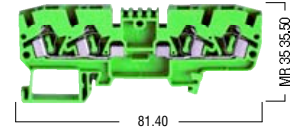

750V~/24A/2.5mm²		750V~/24A/2.5mm²		750V~/24A/2.5mm²		-V~/24A/2.5mm²		
13mm		13mm		13mm		13mm		
0.5-2.5mm²		0.5-2.5mm²		0.5-2.5mm²		0.5-2.5mm²		
0.5-2.5mm²		0.5-2.5mm²		0.5-2.5mm²		0.5-2.5mm²		
22.....10		22.....12		22.....12		22.....12		
Cat.No/No.Cat	Qty./Qt.	Cat.No/No.Cat	Qty./Qt.	Cat.No/No.Cat	Qty./Qt.	Cat.No/No.Cat	Qty./Qt.	
326 200i	50	326 210i	50	326 310i (24 VAC)	50			
				326 320i (24 VDC)	50			
				326 410i (48 VAC)	50			
				326 420i (48 VDC)	50			
				326 610i (110 VAC)	50			
				326 620i (110 VDC)	50			
				326 710i (200 VAC)	50			
				326 720i (200 VDC)	50			
						336 100i	50	
		1000V						
		1A						
		1 N 4007						
Type/Genre		Type/Genre		Type/Genre		Type/Genre		
DINRAIL 1M-SLOT	1m	DINRAIL 1M-SLOT	1m	DINRAIL 1M-SLOT	1m	DINRAIL 1M-SLOT	1m	
DINRAIL 1M-UNSLOT	1m	DINRAIL 1M-UNSLOT	1m	DINRAIL 1M-UNSLOT	1m	DINRAIL 1M-UNSLOT	1m	
DINRAIL 2M-SLOT	2m	DINRAIL 2M-SLOT	2m	DINRAIL 2M-SLOT	2m	DINRAIL 2M-SLOT	2m	
DINRAIL 2M-UNSLOT	2m	DINRAIL 2M-UNSLOT	2m	DINRAIL 2M-UNSLOT	2m	DINRAIL 2M-UNSLOT	2m	
Type/Genre	Cat.No/No.Cat	Qty./Qt.	Type/Genre	Cat.No/No.Cat	Qty./Qt.	Type/Genre	Cat.No/No.Cat	Qty./Qt.
ES4	495 050i	100	ES4	495 050i	100	ES4	495 050i	100
EPSCC	446 270i	10	EPSCC	446 270i	10	EPSCC	446 270i	10
						EPSCCT	446 272i	10
CCS 2.5/2	476 222i	25						
CCS 2.5/3	476 223i	20						
CCS 2.5/4	476 224i	15						
CCS 2.5/10	476 229i	5						
GM	496 110i	50	GM	496 110i	50	GM	496 110i	50

SCPE Series

Spring Clamp Earth Terminals

Bornes de Terre à Ressort

SCPE 2.5
Width/Largeur 5mm
306 220i

Spring clamp earth terminals have the same outer dimensions as the standard SC blocks for the same cross-sections. This enables earth terminal blocks to be mounted directly besides feed-through terminal blocks.

The main characteristics are:

- Low transition resistance
- Non-corroding contacts
- Green/Yellow marking on the insulation.

The main differences between spring clamp earth terminals and the earth terminals with screw connections is the automatic contact when the terminal blocks are attached to the mounting rails.





Les bornes de terre à ressort ont les mêmes dimensions extérieures que les bornes standards de la série SC. Cela permet de les monter directement à côté des bornes de jonction.

Les principales caractéristiques sont:

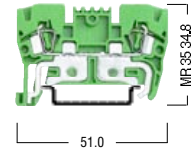
- Faible résistance interne
- Contacts non corrosifs
- Marquage vert/jaune

La principale différence entre les bornes de terre à vis et les bornes de terre à ressort repose sur le fait que le contact se fait automatiquement pour ces dernières.



Electrical ratings/Puissance nominale électrique					
Voltage/Current/Cross section /Tension /Courant /Section nominale	~V~/A/2.5mm ²				
Insulation stripping length/Longueur de dénudement	10mm				
Connection Data/Caractéristiques des connexions					
Solid Strand, Clamp Connection/Fil rigide, Connexion à ressort	0.5-2.5mm ²				
Fine Strand, Clamp Connection/Fil fin, Connexion à ressort	0.5-2.5mm ²				
AWG Conductor/Conducteur AWG	22.....12				
Ordering Data/Références		Cat.No./No.Cat	Qty./Qt.		
Polyamide 6.6.		336 220i	100		
Mounting Rails/Rails de montage		Type/Genre			
MR 35 x 7.5		DINRAIL1M-SLOT	1m		
MR 35 x 7.5 Slotted/Encoche Unslotted/Sans encoche		DINRAIL1M-UNSLOT	1m		
		TS35x7.5 DINRAIL	2m		
		DINRAIL2M-UNSLOT	2m		
End Bracket/Capot d'extrémité		Type/Genre	Cat.No./No.Cat	Qty./Qt.	
	ES4	For/Pour MR 35 & MR 35 GREY/GRIS	ES 4	495 050i	100
End Plate/Partition/Plaque d'extrémité					
Thickness/Epaisseur 1.2mm		Polyamide 6.6 GREEN/VERT	EPPE 2.5	446 322i	100
					
Group Marking/Marquage de groupe					
		GM BEIGE/BEIGE	GM	496 110i	50

SCPE 4

Width/Largeur 6mm
336 230i

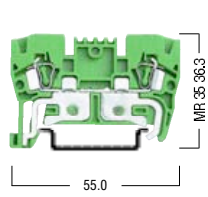

SCPE 6

Width/Largeur 8mm
336 240i

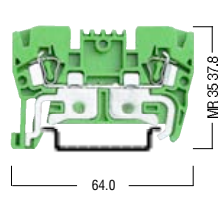

SCPE 10

Width/Largeur 10mm
336 250i

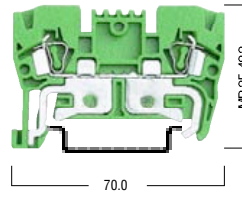

~V~/A/4mm ²		~V~/A/6mm ²		~V~/A/10mm ²	
12mm		13mm		13mm	
0.5-4mm ²		0.5-6mm ²		0.5-10mm ²	
0.5-4mm ²		0.5-6mm ²		0.5-10mm ²	
22.....10		22.....8		20.....6	
Cat.No./No.Cat	Qty./Qt.	Cat.No./No.Cat	Qty./Qt.	Cat.No./No.Cat	Qty./Qt.
336 230i	100	336 240i	100	336 250i	100
Type/Genre		Type/Genre		Type/Genre	
DINRAIL1M-SLOT	1m	DINRAIL1M-SLOT	1m	DINRAIL1M-SLOT	1m
DINRAIL1M-UNSLLOT	1m	DINRAIL1M-UNSLLOT	1m	DINRAIL1M-UNSLLOT	1m
TS35x7.5 DINRAIL	2m	TS35x7.5 DINRAIL	2m	TS35x7.5 DINRAIL	2m
DINRAIL2M-UNSLLOT	2m	DINRAIL2M-UNSLLOT	2m	DINRAIL2M-UNSLLOT	2m
Type/Genre	Cat.No./No.Cat	Qty./Qt.	Type/Genre	Cat.No./No.Cat	Qty./Qt.
ES 4	495 050i	100	ES 4	495 050i	100
EPPE 4	446 332i	100	EPPE 6	446 342i	100
GM	496 110i	50	GM	496 110i	50

SCD 2.5 Series

Double Deck Spring Clamp Terminals Bornes à Ressort à Deux Niveaux







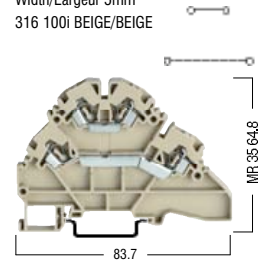

Double deck spring clamp terminals provide easiness if there is a limited space for cable assembly. Double deck terminals with electronic components can also be used in various applications.

Les bornes à ressort à deux niveaux facilitent l'assemblage des câbles lorsque l'espace est limité. Les bornes à deux niveaux avec composants électroniques peuvent aussi être utilisées pour diverses applications.

SCD 2.5

Width/Largeur 5mm
316 100i BEIGE/BEIGE



Electrical ratings/Puissance nominale électrique				
Voltage/Current/Cross section /Tension/Courant/Section nominale		500V~/24A/2.5mm ²		
Insulation stripping length/Longueur de dénudement		10mm		
Connection Data/Caractéristiques des connexions				
Solid Strand, Clamp Connection/Fil rigide, Connexion à ressort		0.5-2.5mm ²		
Fine Strand, Clamp Connection/Fil fin, Connexion à ressort		0.5-2.5mm ²		
AWG Conductor/Conducteur AWG		22.....12		
Ordering Data/Références		Cat.No/No.Cat	Qty/Qt.	
Polyamide 6.6.	BEIGE/BEIGE	SCD2.5 316 100i	50	
Electrical Ratings/Puissance nominale électrique				
Diode Reverse Voltage/Diode à tension inverse				
Diode Current/Courant de diode				
Diode/Diode				
Mounting Rails/Rails de montage		Type/Genre		
MR 32	MR 35 x 7.5	DINRAIL1M-SLOT	1m	
	MR 35 x 7.5	DINRAIL1M-UNSLLOT	1m	
	Slotted/Encoche Unslotted/Sans encoche	DINRAIL2M-SLOT	2m	
		DINRAIL2M-UNSLLOT	2m	
				
DIN EN 50035	DIN EN 50022			
End Bracket/Capot d'extrémité		Type/Genre	Cat.No/No.Cat	Qty/Qt.
	ES4 For/Pour MR 35 BEIGE/BEIGE	ES4	495 050i	100
End Plate/Partition/Plaque d'extrémité		Type/Genre	Cat.No/No.Cat	Qty/Qt.
	EPSCD2.5 Polyamide 6.6 Thickness/Epaisseur 1.5mm	BEIGE/BEIGE	EPSCD2.5 446 290i	50
Cross-Connection/Barrettes de jonction		Type/Genre	Cat.No/No.Cat	Qty/Qt.
	CCS 2.5/2	476 222i	25	
	CCS 2.5/3	476 223i	20	
	CCS 2.5/4	476 224i	15	
	CCS 2.5/10	476 229i	5	
Group Marking/Marquage de groupe		Type/Genre	Cat.No/No.Cat	Qty/Qt.
	GM BEIGE/BEIGE	GM	496 110i	50

SCD 4 Series

Double-Deck Spring Terminals

Bornes à Ressort à Deux Niveaux

IMO double level spring terminals are the answer to high wiring density problems posed by certain unavoidable wiring arrangements. Besides this double level terminals have the following advantages:

- Double wiring density available without extension mounting rails
- Interconnection/shorting can be done at both levels
- Marking/identification by making tags possible at both levels.

Les bornes à ressort à deux niveaux IMO autorisent une haute densité de câblage. Elles offrent les avantages suivants:

- La densité de câblage est double sur la même longueur de rail
- Les connexions internes peuvent être faites sur les deux niveaux
- Le marquage peut, lui aussi, être fait sur les deux niveaux

SCD 4

Width/Largeur 6mm
318 100i BEIGE/BEIGE

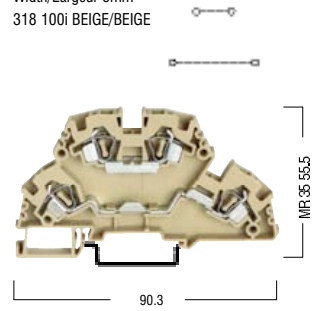

Electrical ratings/Puissance nominale électrique				
Voltage/Current/Cross section /Tension /Courant/Section nominale	750V~/30A/4mm ²			
UL/UL	600V~/26A/AWG 22-10			
Insulation stripping length/Longueur de dénudement	12mm			
Connection Data/Caractéristiques des connexions				
Solid Strand, Clamp Connection/Fil rigide, Connexion à ressort	0.5-4mm ²			
Fine Strand, Clamp Connection/Fil fin, Connexion à ressort	0.5-4mm ²			
AWG Conductor/Conducteur AWG	22.....10			
Ordering Data/Références		Type/Genre	Cat.No/No.Cat	Qty/Qt.
Polyamide 6.6.		SCD 4	318 100i	50
Electrical Ratings/Puissance nominale électrique				
Diode Reverse Voltage/Diode à tension inverse				
Diode Current/Courant de diode				
Diode/Diode				
Mounting Rails/Rails de montage		Type/Genre		
MR 35 x 7.5		DINRAIL1M-SLOT		1m
MR 35 x 7.5 Slotted/Encoche		DINRAIL1M-UNSLLOT		1m
Unslotted/Sans encoche		TS35x7.5 DINRAIL		2m
		DINRAIL2M-UNSLLOT		2m
End Bracket/Capot d'extrémité		Type/Genre	Cat.No/No.Cat	Qty/Qt.
	ES4	BEIGE/BEIGE	ES4	495 050i
End Plate/Partition/Plaquette d'extrémité				
	Thickness/Epaisseur 1.5mm	Polyamide 6.6. BEIGE/BEIGE	EPSCD4	446 260i
Cross-Connection/Barrettes de jonction				
			CCS4/2	476 232i
			CCS4/3	476 233i
			CCS4/4	476 234i
			CCS4/10	476 239i
Group Marking/Marquage de groupe		GM	BEIGE/BEIGE	GM
			GM	496 110i

SCF Series

Spring Clamp Fuse and Disconnect Terminals Bornes à Ressort Porte-Fusibles Déconnectables

Spring clamp fuse and disconnect terminals are designed to be used with 5x20 - 5x25 fuses and busbars as an industrial standard and 6.35mm x 31.75mm (1/4"x1 1/4") fuses and busbars as an American standard.

Les bornes à ressort porte-fusibles déconnectables utilisent les fusibles ou cartouche neutre au standard industriel 5x20 - 5x25 et les fusibles ou cartouche neutre au standard américain 6,35 x 31,75 mm (1/4"x1 1/4").





SCF3

Width/Largeur 8mm
355 110i BEIGE/BEIGE
Fuse Size/Taille du Fusible
5x20mm
5x25mm

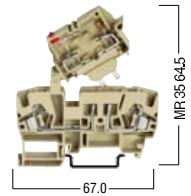
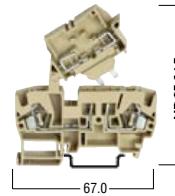
SCF3LD

Width/Largeur 8mm
355 _0i BEIGE/BEIGE
Fuse Size/Taille du Fusible
5x20mm
5x25mm



Electrical ratings/Puissance nominale électrique							
Voltage/Current/Cross section /Tension /Courant/Section nominale	500V~/~/A/4mm ²			-V~/~/A/4mm ²			
UL/cUL	600V~/~/AWG 22-10			600V~/~/AWG 22-10			
Insulation stripping length/Longueur de dénudement	12mm			12mm			
Connection Data/Caractéristiques des connexions							
Solid Strand, Clamp Connection/Fil rigide, Connexion à ressort	0.5.....4mm ²			0.5.....4mm ²			
Fine Strand, Clamp Connection/Fil fin, Connexion à ressort	0.5.....4mm ²			0.5.....4mm ²			
AWG Conductor/Conducteur AWG	22.....10			22.....10			
Ordering Data/Références							
Polyamide 6.6.	Type/Genre	Cat.No/No.Cat	Qty/Qt.	Type/Genre	Cat.No/No.Cat	Qty/Qt.	
	SCF3	355 110i	20	SCF3LD	355 710i (24 VAC)	20	
				SCF3LD	355 720i (24 VDC)	20	
				SCF3LD	355 730i (48 VAC)	20	
				SCF3LD	355 740i (48 VDC)	20	
				SCF3LD	355 750i (110 VAC)	20	
				SCF3LD	355 760i (110 VDC)	20	
				SCF3LD	355 770i (220 VAC)	20	
				SCF3LD	355 780i (220 VDC)	20	
Mounting Rails/Rails de montage							
	Type/Genre			Type/Genre			
	DINRAIL1M-SLOT	1m		DINRAIL1M-SLOT	1m		
MR 35 x 7.5	DINRAIL1M-UNSLLOT	1m		DINRAIL1M-UNSLLOT	1m		
MR 35 x 7.5 Slotted/Encoche	TS35x7.5 DINRAIL	2m		TS35x7.5 DINRAIL	2m		
Unslotted/Sans encoche	DINRAIL2M-UNSLLOT	2m		DINRAIL2M-UNSLLOT	2m		
	DIN EN 50022						
End Bracket/Capot d'extrémité							
	Type/Genre	Cat.No/No.Cat	Qty/Qt.	Type/Genre	Cat.No/No.Cat	Qty/Qt.	
 ES4	For/Pour MR 35 & MR 35 GREY/GRIS	ES 4	495 050i	100	ES 4	495 050i	100
End Plate/Partition/Plaquette d'extrémité							
	Thickness/Epaisseur	EP SCF3	450 050i	10	EP SCF3	450 050i	10
							
Cross-Connection/Barrettes de jonction							
	CCS 6/2	476 242i	25	CCS 6/2	476 242i	25	
	CCS 6/3	476 243i	20	CCS 6/3	476 243i	20	
	CCS 6/4	476 244i	15	CCS 6/4	476 244i	15	
	CCS 6/10	476 249i	5	CCS 6/10	476 249i	5	
							
Group Marking/Marquage de groupe							
	GM BEIGE/BEIGE	GM	496 110i	50	GM	496 110i	50
							

SCT Series

Spring Clamp Terminals for Initiators, Actuators and Motors Bornes à Ressort pour Capteurs, Actionneurs et Moteurs

SCT 3

Width/Largeur 6mm
324 500i BEIGE/BEIGE

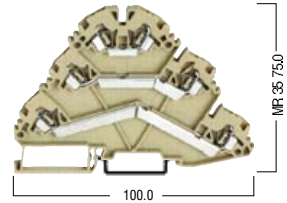

3 and 4 wired elements such as motors, sensors, actuators and initiators are commonly used in industry. The multi level terminal blocks (SCT 3, SCT 3E) are designed and developed to meet the demanding requirements of 3 or 4 wire applications.

Signal, power and ground can be connected on a single, compact 6mm width terminal block.

Multi level terminal blocks:

- Make wiring more practical
- Reduce the installation costs and speed the wiring.
- Provide individual cross connections for each layer. They are used at the edge of sensor terminal blocks.
- Provide definitive identification of positive, negative and ground connections with the help of internationally accepted colours for the related layers. Because of this property, they minimise wiring mistakes and speed wiring.
- Are ideal for limited spaces because of their compact designs.

Les composants à 3 ou 4 fils tels que les moteurs, les capteurs, les actionneurs, les détecteurs sont fréquemment utilisés dans l'industrie. Les bornes à niveaux multiples (SCT 3, SCT 3E) ont été conçues et développées pour répondre aux exigences des applications à 3 ou 4 fils. Le signal, la puissance et la terre peuvent être connectés sur un simple bloc de jonction de 6 mm d'épaisseur.

Les bornes à niveaux multiples:

- Rendent le câblage plus pratique.
- Réduisent le coût de l'installation et le temps de câblage.
- Fournissent des connexions internes pour chaque niveau. Elles sont utilisées à l'extrémité des bornes de jonction pour détecteurs.
- Permettent une bonne identification du positif, du négatif et de la terre grâce aux couleurs aux normes internationales.
- Diminuent le temps de câblage et réduisent les erreurs.
- Sont idéales dans un espace limité grâce à leur concept compact.

Electrical ratings/Puissance nominale électrique

Voltage/Curent/Cross section /Tension /Courant /Section nominale	500V~/20A/2.5mm ²
UL/cUL	600V~/20A/AWG 22-12
Insulation stripping length/Longueur de dénudement	10mm

Connection Data/Caractéristiques des connexions

Solid Strand, Clamp Connection/Fil rigide, Connexion à ressort	0.5-2.5mm ²
Fine Strand, Clamp Connection/Fil fin, Connexion à ressort	0.5-2.5mm ²
AWG Conductor/Conducteur AWG	22.....12

Ordering Data/Références

		Cat.No/No.Cat	Qty/Qt.	
Polyamide 6.6.	BEIGE/BEIGE	SCT 3	324 500i	20

Mounting Rails/Rails de montage

	Type/Genre	
MR 35 x 7.5	DINRAIL1M-SLOT	1m
MR 35 x 7.5 Slotted/Encoche	DINRAIL1M-UNSLLOT	1m
Unslotted/Sans encoche	TS35x7.5 DINRAIL	2m
	DINRAIL2M-UNSLLOT	2m



End Bracket/Capot d'extrémité

	Type/Genre	Cat.No/No.Cat	Qty/Qt.	
ES4	For/Pour MR 35 & MR 35 BEIGE/BEIGE	ES4	495 050i	100



End Plate/Partition/Plaque d'extrémité

Thickness/Epaisseur	1.2mm	Polyamide 6.6.	BEIGE/GEIGE	EP SCT3	446 240i	10
---------------------	-------	----------------	-------------	---------	----------	----



Cross-Connection/Barrettes de jonction

	CCS 2.5/2T	476 222i	25
	CCS 2.5/3T	476 223i	20
	CCS 2.5/4T	476 224i	10
	CCS 2.5/10T	476 229i	5

Group Marking/Marquage de groupe

	GM	BEIGE/BEIGE	GM	496 110i	50
--	----	-------------	----	----------	----



SCT3 Series

Three Level Spring Clamp Sensor Terminals Bornes à Ressort à Trois Niveaux pour Détecteurs





In the field of machine constructions, inductive or capacitive proximity switches are increasingly used for actuation without physical contact. In general they are designed as "Three Wire Sensors". The positive and negative conductor transmits the switching pulses ERT 3S terminal blocks minimise wiring time and costs and cabinet space when terminating three wire devices such as sensors, proximity switches etc.

On utilise de plus en plus de détecteurs sans contact sur les machines automatiques tels que: détecteurs photoélectrique, inductifs, capacitifs. Généralement ils utilisent une technologie 3 fils. L'impulsion de commutation est transmise par les conducteurs positifs et négatifs. L'utilisation des bornes ERT 3S permet de réduire le temps de câblage, le coût et l'espace occupée dans les armoires.

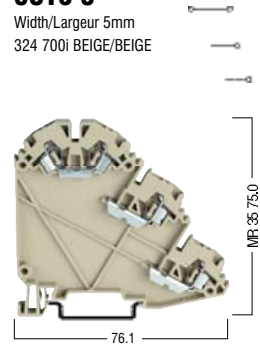
SCT3 S

Width/Largeur 5mm
324 700i BEIGE/BEIGE



Electrical ratings/Puissance nominale électrique						
Voltage/Curent/Cross section /Tension /Courant /Section nominale	500V~/20A/2.5mm ²					
Insulation stripping length/Longueur de dénudement	10mm					
Connection Data/Caractéristiques des connexions						
Solid Strand, Clamp Connection/Fil rigide, Connexion à ressort	0.5-2.5mm ²					
Fine Strand, Clamp Connection/Fil fin, Connexion à ressort	0.5-2.5mm ²					
AWG Conductor/Conducteur AWG	22.....12					
Ordering Data/Références			Cat.No/No.Cat	Qty/Qt.		
Polyamide 6.6.	BEIGE/BEIGE	SCT3S	324 700i	20		
Mounting Rails/Rails de montage				Type/Genre		
MR 35 x 7.5				DINRAIL1M-SLOT	1m	
MR 35 x 7.5 Slotted/Encoche				DINRAIL1M-UNSLLOT	1m	
Unslotted/Sans encoche				TS35x7.5 DINRAIL	2m	
				DINRAIL2M-UNSLLOT	2m	
End Bracket/Capot d'extrémité				Type/Genre	Cat.No/No.Cat	Qty/Qt.
	ES4	For/Pour MR 35 & MR 35	BEIGE/BEIGE	ES4	495 050i	100
End Plate/Partition/Plaque d'extrémité				Type/Genre	Cat.No/No.Cat	Qty/Qt.
	EPSC3S	Polyamide 6.6.	BEIGE/BEIGE	EP SCT3S	446 280i	10
		Thickness/Epaisseur 1.5mm				
Cross-Connection/Barrettes de jonction				Type/Genre	Cat.No/No.Cat	Qty/Qt.
				CCS 2.5/2T	476 222i	25
				CCS 2.5/3T	476 223i	20
				CCS 2.5/4T	476 224i	10
				CCS 2.5/10T	476 229i	5
Group Marking/Marquage de groupe				Type/Genre	Cat.No/No.Cat	Qty/Qt.
				GM	496 110i	50

SCT3 SLD

Width/Largeur 5mm
324 710i BEIGE/BEIGE

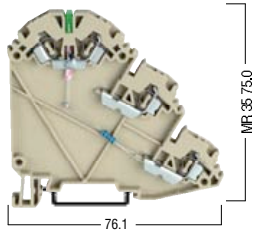

SCT3 SLD

Width/Largeur 6mm
324 720i BEIGE/BEIGE

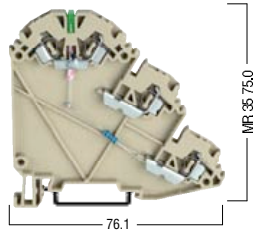

500V~/20A/2.5mm ²			500V~/20A/2.5mm ²		
10mm			10mm		
0.5-2.5mm ²			0.5-2.5mm ²		
0.5-2.5mm ²			0.5-2.5mm ²		
22.....12			22.....12		
	Cat.No/No.Cat	Qty/Qt.		Cat.No/No.Cat	Qty/Qt.
SCT3	324 710i	20	SCT3	324 720i	25
Type/Genre			Type/Genre		
DINRAIL1M-SLOT		1m	DINRAIL1M-SLOT		1m
DINRAIL1M-UNSLOT		1m	DINRAIL1M-UNSLOT		1m
TS35x7.5 DINRAIL		2m	TS35x7.5 DINRAIL		2m
DINRAIL2M-UNSLOT		2m	DINRAIL2M-UNSLOT		2m
Type/Genre	Cat.No/No.Cat	Qty/Qt.	Type/Genre	Cat.No/No.Cat	Qty/Qt.
ES4	495 050i	100	ES4	495 050i	100
EP SCT3S	446 280i	10	EP SCT3S	446 280i	10
CCS 2.5/2T	476 222i	25	CCS 2.5/2T	476 222i	25
CCS 2.5/3T	476 223i	20	CCS 2.5/3T	476 223i	20
CCS 2.5/4T	476 224i	10	CCS 2.5/4T	476 224i	10
CCS 2.5/10T	476 229i	5	CCS 2.5/10T	476 229i	5
GM	496 110i	50	GM	496 110i	50

PM Series

Panel Mounting Terminals

Bornes pour Montage en Armoire

PM2.5
Width/Largeur 6mm

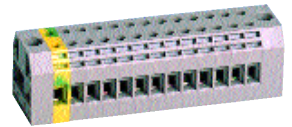

These are small panel mounting type terminal blocks available in 2.5mm², 4mm² and 10mm² sizes.

The standard single units can be combined together using the heavy duty buckles and spaces in order to make different length products; whilst, the versatility of this series allows for the 2.5mm² and 4mm² products to be mixed and assembled together.

The PM series can accommodate the standard marking labels for identification of the blocks when wiring.

Cette série comprend des petits borniers pour montage en armoire disponibles en 2,5 mm², 4 mm² et 10 mm². Les unités simples standard peuvent se combiner à l'aide de languettes robustes pour obtenir des produits de différentes longueurs; la flexibilité de cette série permet de mélanger et d'assembler des produits de 2,5 mm² et de 4 mm².

La série PM accepte les étiquettes standard pour identifier les borniers pendant le câblage.

Technical data/Données technique	UL	IEC
Rated Voltage/Tension assignée	300V	400V
Rated Current/Courant assigné	20A	24A
Wire Range/Gamme des fils	2.5mm ²	
Connection Data/Caractéristiques des connexions		
Solid wire (AWG)/Fil rigide (AWG)	22-12	
Stranded wire (AWG)/Fil standard (AWG)	22-12	
Insulation withstand voltage/Tension de tenue d'isolement	2kv	
Torque (Nm)/Couple	0.4	
Screw/Vis	M2.5	
Wire Strip length/Longueur isolée du fil	6-8mm	
Part No./Numéro d'identification		
End Plate/Partition/Plaque d'extrémité	PMC2.5/4	
Role/Pôle	PM2.5	
Earth/Terre	PME2.5	

PM4

Width/Largeur 6mm

PM10

Width/Largeur 8mm

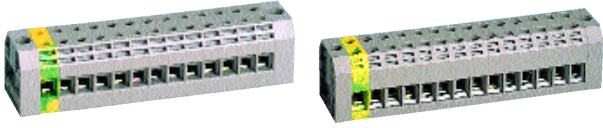

UL	IEC	UL	IEC
300V	400V	300V	400V
30A	34A	45A	57A
4mm ²		10mm ²	
22-10		22-8	
22-10		22-8	
2kv		2kv	
0.8		1.8	
M3		M4	
6-8mm		9-11mm	
PMC2.5/4		PMC10	
PM4		PM10	
PME4		PME10	

Terminal Strips Barrette de Connexion

TS1



TS2

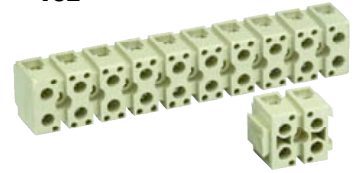

Electrical ratings/Puissance nominale électrique			
Voltage/Current/Cross section /Tension /Courant /Section nominale	380V~ /25A /2.5mm ²	600V~ /47A /6mm ²	
VDE/VDE (IEC 60998-1, IEC 60998-2-1)	400V~ /24A /2.5mm ²	660V~ /41A /6mm ²	
Insulation stripping length/Longueur de dénudage	5mm	9mm	
Ordering Data/Références			
Can be joined end to end/Peut être joint bord à bord	Type/Genre	Cat. No./No.Cat	Qty/Qt.
	TS1/2 (2 way)	420 020i	100
	TS1/12 (12 way)	420 120i	75
	Type/Genre	Cat. No./No.Cat	Qty/Qt.
	TS2/2 (2 way)	421 020i	100
	TS2/10 (10way)	421 100i	30
Group Marking/Marquage de groupe			
		GM6	496 270i 25

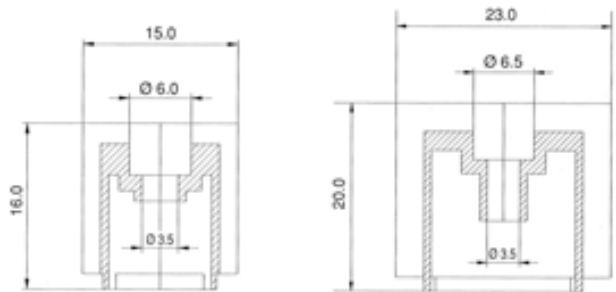

Busbars Barre de Distribution

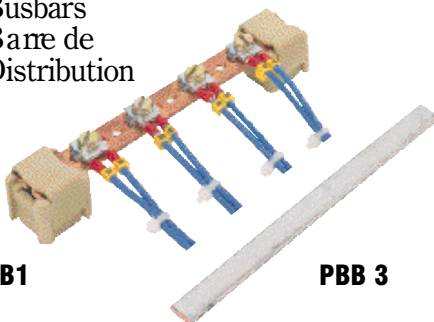

BB1

PBB 3

Type/Genre	Cat.No/No.Cat	Current/Courant	Material/Matériau	Dim/Dim. (mm)	Qty/Qt.
BB1	525 100i	80 A	E-Cu	15 x 2	1m
BB1/2	525 101i	80 A	E-Cu	15 x 2	50cm
BB2	525 200i	140 A	E-Cu	15 x 3	1m
BB2/2	525 201i	140 A	E-Cu	15 x 3	50cm
BB3	525 300i	80 A	E-Cu	10 x 3	1m
PBB 3	525 350i	80 A	Tin plated E-Cu/Fer blanc E-Cu	10 x 3	1m

Single strand screw connection/Simple brin connexion à vis 0,5.....2,5 mm² Longueur de dénudage : 9 mm

Busbar Support Block Support pour Barre de Distribution

BSB1

Type/Genre	BSB1
Cat.No/No.Cat	528 110i
Dim/Dim. (mm)	15 x 2, 15 x 3, 12 x 2 10 x 3, 6 x 6
Material/Matériau	PA 6.6
Qty/Qt.	50

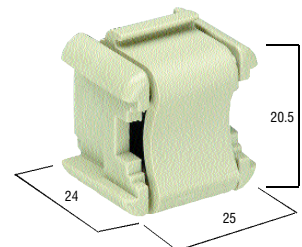

Clamping Yokes Bornes de Serrage

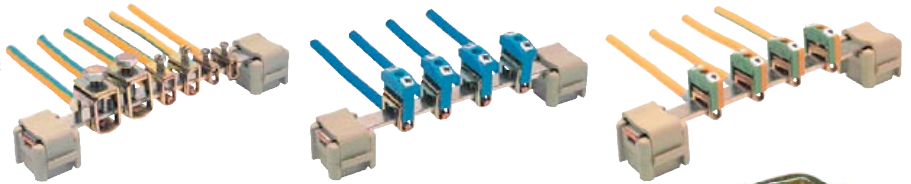

The clamping yokes can be slid onto the 10 x 3 busbar up to 50mm² and the entire wiring matched to the installation.

Les bornes de serrage permettent de relier les câbles d'alimentation (jusqu'à une section de 50 mm²) à la barre de distribution.

CC4

525 361i



CC10

525 362i



CC35

525 363i

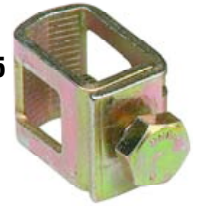

Electrical ratings/Puissance nominale électrique								
Cross section/Section nominale	4mm ²		10mm ²		35mm ²			
Insulation stripping length/Longueur de dénudage	16mm		19mm		19mm			
Fixing Screw/Vis de fixation	M 3		M 4		M 6			
Busbar Dimensions/Dimensions de la barre de distribution	10 x 3		10 x 3		10 x 3			
Isolation Cap/Capote d'isolation	-		-		-			
Connection Data/Caractéristiques des connexions								
Solid Strand/Câble monobrin	0.5.....6mm ²		1.5.....10mm ²		16.....50mm ²			
Fine Strand/Câble multibrin	0.5.....4mm ²		2.5.....10mm ²		16.....35mm ²			
Ordering Data/Références								
Type/Genre	Cat.No/No.Cat	Qty./Qt.	Type/Genre	Cat.No/No.Cat	Qty./Qt.	Type/Genre	Cat.No/No.Cat	Qty./Qt.
CC4	525 361i	200	CC10	525 362i	100	CC35	525 363i	50

CCB type clamping yokes are designed with blue insulation caps in order to indicate connection to the N-Lead. They can be used with marking tags.

Les bornes de serrage CCB peuvent être livrées avec des capots d'isolation bleus permettant d'identifier le neutre. Elles peuvent être repérées par des étiquettes.

CCB 4

525 371i



CCB 10

525 372i



CCB 35

525 373i



Electrical ratings/Puissance nominale électrique								
Cross section/Section nominale	4mm ²		10mm ²		35mm ²			
Insulation stripping length/Longueur de dénudage	16mm		19mm		19mm			
Fixing Screw/Vis de fixation	M 3		M 4		M 6			
Busbar Dimensions/Dimensions de la barre de distribution	10 x 3		10 x 3		10 x 3			
Isolation Cap/Capote d'isolation	BLUE/BLU		BLUE/BLU		BLUE/BLU			
Connection Data/Caractéristiques des connexions								
Solid Strand/Câble monobrin	0.5.....6mm ²		1.5.....10mm ²		16.....50mm ²			
Fine Strand/Câble multibrin	0.5.....4mm ²		2.5.....10mm ²		16.....35mm ²			
Ordering Data/Références								
Type/Genre	Cat.No/No.Cat	Qty./Qt.	Type/Genre	Cat.No/No.Cat	Qty./Qt.	Type/Genre	Cat.No/No.Cat	Qty./Qt.
CCB 4	525 371i	100	CCB10	525 372i	100	CCB35	525 373i	50

CC4 G/Y type clamping yokes are designed with yellow, green insulation caps to emphasise the protection function. They can be used with marking tags.

Les bornes de serrage CC4 G/Y peuvent être livrées avec ces capots d'isolation de couleur jaune et vert afin de mettre en évidence la fonction de protection. Elles peuvent être repérées par des étiquettes.

CCB4 Y/G

525 381i



CCB10 G/Y

525 382i



CC35 Y/G

525 383i



Electrical ratings/Puissance nominale électrique								
Voltage/Current/Cross section/Tension /Courant/Section nominale	380V~ 450V/4mm ²		380V~ 450V/10mm ²		380V~ 450V/35mm ²			
Insulation stripping length/Longueur de dénudage	16mm		19mm		19mm			
Fixing Screw/Vis de fixation	M 3		M 4		M 6			
Busbar Dimensions/Dimensions de la barre de distribution	10 x 3		10 x 3		10 x 3			
Isolation Cap/Capote d'isolation	Green/Yellow/Vert/Jaune		Green/Yellow/Vert/Jaune		Green/Yellow/Vert/Jaune			
Connection Data/Caractéristiques des connexions								
Solid Strand/Câble monobrin	0.5.....6mm ²		1.5.....10mm ²		16.....50mm ²			
Fine Strand/Câble multibrin	0.5.....4mm ²		2.5.....10mm ²		16.....35mm ²			
Ordering Data/Références								
Type/Genre	Cat.No/No.Cat	Qty./Qt.	Type/Genre	Cat.No/No.Cat	Qty./Qt.	Type/Genre	Cat.No/No.Cat	Qty./Qt.
CCB4 Y/G	525 381i	100	CCB10 G/Y	525 382i	100	CC35 Y/G	525 383i	50

Marking Tags Les Étiquettes de Marquage

MT5 1-50

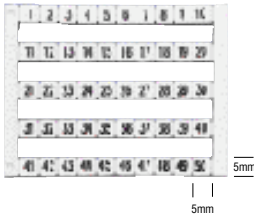

MT5

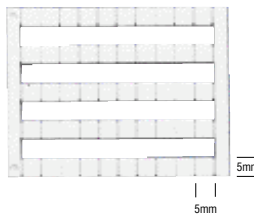

MT5 Special

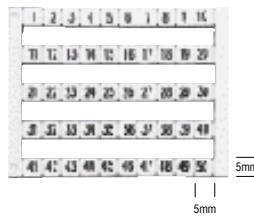

Max. 2 digits can be printed for MT5 Special. MT5 marker can be used with the whole terminal range.

Un maximum de 2 chiffres peuvent être imprimés sur les étiquettes MT5 Special. Les étiquettes MT5 peuvent être utilisées avec toute la gamme de bornes de jonction.

MT 10/5

MT 10/5

Max. 5 digits can be printed for MT10/5 and MT10/6.5

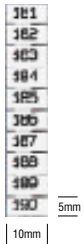
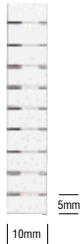

Un maximum de 5 chiffres peut être imprimé sur les étiquettes MT10/5 et MT10/6.5

MT 10/5 and MT10/15 type marking tags can be used with the following terminals ER (4...70) ERPEG, ERWT

Les étiquettes MT10/6 peuvent être utilisées avec les bornes suivantes : ER(4...70), ERPEG, ERWT

MT10/6



MT10/6 type marking tags can be used with the following terminals ER(4...70), ERPEG, ERWT

Les étiquettes MT10/5 et MT10/15 peuvent être utilisées avec les bornes suivantes: ER(4...70), ERPEG, ERW

MT 10/6.5- MT 10/6.5 MT 10/6.5-... 1-10

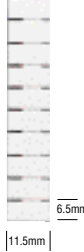

MT10/6.5-1-10, MT10/6.5 and MT10/6.5 type marking tags can be used with the following terminals ER(6...70), ERPEG(6...35) ERWT

Les étiquettes MT10/6.5-1-1, MT10/6.5, MT10/6.5-... peuvent être utilisées avec les bornes suivantes: ER(6...70), ERPEG (6...35), ERWT.

Type/Genre	Description/Description	Cat.No/No.Cat	Qty/Qt
MT 5	Standard print/Impression standard	505 ---i	500 plate/plaquette
MTO 5	Special print/Impression spéciale	505 650i	500 plate/plaquette
MT 5	Without print/Sans Impression	505 850i	500 plate/plaquette
MT 10/5	Special print/Impression spéciale	505 710i	500 plate/plaquette
MT 10/5	Without print/Sans Impression	505 910i	500 plate/plaquette
MT 10/6	Without print/Sans Impression	505 915i	500 plate/plaquette
MT 10/6.5	Standard print/Impression standard	505 ---i	500 plate/plaquette
MT 10/6.5	Special print/Impression spéciale	505 720i	500 plate/plaquette
MT 10/6.5	Without print/Sans Impression	505 920i	500 plate/plaquette

Type Genre	Description Description	Cat.No No.Cat	Type Genre	Description Description	Cat.No No.Cat	Type Genre	Description Description	Cat.No No.Cat	Type Genre	Description Description	Cat.No No.Cat
MT 5	0	505 000i	MT 5	51-100	505 041i	MT 5	951-999	505 059i	MT 5	R	505 077i
MT 5	1	505 001i	MT 5	100-150	505 042i	MT 5	A	505 060i	MT 5	S	505 078i
MT 5	2	505 002i	MT 5	151-200	505 043i	MT 5	B	505 061i	MT 5	T	505 079i
MT 5	3	505 003i	MT 5	201-250	505 044i	MT 5	C	505 062i	MT 5	U	505 080i
MT 5	4	505 004i	MT 5	251-300	505 045i	MT 5	D	505 063i	MT 5	V	505 081i
MT 5	5	505 005i	MT 5	301-350	505 046i	MT 5	E	505 064i	MT 5	W	505 082i
MT 5	6	505 006i	MT 5	351-400	505 047i	MT 5	F	505 065i	MT 5	X	505 083i
MT 5	7	505 007i	MT 5	401-450	505 048i	MT 5	G	505 066i	MT 5	Y	505 084i
MT 5	8	505 008i	MT 5	451-500	505 049i	MT 5	H	505 067i	MT 5	Z	505 085i
MT 5	9	505 009i	MT 5	501-550	505 050i	MT 5	I	505 068i	MT 5	L1	505 090i
MT 5	10	505 010i	MT 5	551-600	505 051i	MT 5	J	505 069i	MT 5	L2	505 091i
MT 5	1-10	505 020i	MT 5	601-650	505 052i	MT 5	K	505 070i	MT 5	L3	505 092i
MT 5	11-20	505 021i	MT 5	651-700	505 053i	MT 5	L	505 071i	MT 5	RSNT±	505 093i
MT 5	21-30	505 022i	MT 5	701-750	505 054i	MT 5	M	505 072i	MT 5	Mp	505 094i
MT 5	31-40	505 023i	MT 5	751-800	505 055i	MT 5	N	505 073i	MT 5	+	505 095i
MT 5	41-50	505 024i	MT 5	801-850	505 056i	MT 5	O	505 074i	MT 5	-	505 096i
MT 5	10-100	505 030i	MT 5	851-900	505 057i	MT 5	P	505 075i	MT 5	±	505 097i
MT 5	1-50	505 040i	MT 5	901-950	505 058i	MT 5	Q	505 076i			

Type Genre	Description Description	Cat.No No.Cat
MT 10/6.5	1-10	505 201i
MT 10/6.5	11-20	505 202i
MT 10/6.5	21-30	505 203i
MT 10/6.5	31-40	505 204i
MT 10/6.5	41-50	505 205i
MT 10/6.5	51-60	505 206i
MT 10/6.5	61-70	505 207i
MT 10/6.5	71-80	505 208i
MT 10/6.5	81-90	505 209i
MT 10/6.5	91-100	505 210i

Part No	Code	Page
21.950M/--		40-41
BSB1	528110i	58
CC10/10	474759i	17
CC10/10W	480179i	36
CC10/2	474152i	17
CC10/2W	480172i	36
CC10/3	474153i	17
CC10/3W	480173i	36
CC10/4	474154i	17
CC10/4W	480174i	36
CC10/6W	480176i	36
CC16/10	474169i	17
CC16/2	474162i	17
CC16/3	474163i	17
CC16/4	474164i	17
CC2.5/10	474129i	16
CC2.5/10T	480139i	26-28
CC2.5/2	474122i	16
CC2.5/2T	480132i	26-28
CC2.5/3	474123i	16
CC2.5/3T	480133i	26-28
CC2.5/4	474124i	16
CC2.5/4T	480134i	26-28
CC35/10	474179i	17
CC35/2	474172i	17
CC35/3	474173i	17
CC35/4	474174i	17
CC4	525361i	59
CC4/10	474139i	16
CC4/2	474132i	16
CC4/3	474133i	16
CC4/4	474134i	16
CC6/10	474149i	17
CC6/2	474142i	17
CC6/3	474143i	17
CC6/4	474144i	17
CCB4 BLUE	525371i	59
CCB4Y/G	525381i	59
CCS2.5/10	476229i	38
CCS2.5/2	476222i	38
CCS2.5/3	476223i	38
CCS2.5/4	476224i	38
CCS4/10	476239i	39
CCS4/2	476223i	39
CCS4/3	476233i	39
CCS4/4	476234i	39
EP1.5-4	444420i	14
EP16 BEIGE	444169i	17
EP2.5-10 BEIGE	444129i	16-17
EP4 BEIGE	449010i	22-25
EP4C	450170i	18
EPERD4F	420200i	31
EPF2 BEIGE	450040i	31-32
EPF3 BEIGE	450050i	30-31,33
EPS10	446350i	39
EPS2.5	446320i	38
EPS4	446330i	39
EPS6	446340i	39
EPT2E BEIGE	450150i	27
EPT3 BEIGE	450130i	26
EPT3E BEIGE	450140i	27
EPT3S	450160i	28-29
EPWT BEIGE	450120i	36
ER10 BEIGE	304159i	17
EPPE2.5	446322i	44
EPPE4	446332i	45

Part No	Code	Page
EPPE6	446342i	45
EPPE10	446352i	45
ER16 BEIGE	304169i	17
EPSC2.5 BEIGE	450190i	40-41
EPSCD2.5	446290i	46-47
EPSCD4	446260i	48-49
EPSCPE	446210i	42
EPSCt3	446240i	52
EPSCD2.5	446290i	53
EPSCt3S	446280i	54-55
ER2.5 BEIGE	304129i	16
ER2.5 BLACK	304125i	16
ER2.5 BLUE	304121i	16
ER2.5 GREEN	304122i	16
ER2.5 ORANGE	304127i	16
ER2.5 RED	304124i	16
ER2.5 WHITE	304126i	16
ER2.5 YELLOW	304123i	16
ER2.5-T15	304420i	14
ER35 BEIGE	304179i	17
ER4 BEIGE	304139i	16
ER4 BLACK	304135i	16
ER4 BLUE	304131i	16
ER4C	325100i	18
ER4 GREEN	304132i	16
ER4 ORANGE	304137i	16
ER4 RED	304134i	16
ER4 WHITE	304136i	16
ER4 YELLOW	304133i	16
ER4-T15	304430i	14
ERF4 BEIGE	351120i	34
ER6 BEIGE	304149i	17
ERT0 BEIGE	304199i	17
ERB150	304319i	21
ERB240	304329i	21
ERB95	304309i	20
ERD2.5BEIGE	317100i	22
ERD2.5D	317220i	23
ERD2.5LD	317---	23
ERD2.5V	317120i	23
ERD4 BEIGE	319100i	24
ERD4D BEIGE	319220i	25
ERD4F BEIGE	353300i	31
ERD4LD110AC	319610i	25
ERD4LD110DC	319620i	25
ERD4LD220AC	319710i	25
ERD4LD220DC	319720i	25
ERD4LD24AC	319310i	25
ERD4LD24DC	319320i	25
ERD4LD48AC	319410i	25
ERD4LD48DC	319420i	25
ERD4V BEIGE	319120i	25
ERTD10/16	395100i	37
ERTD10/16-2	395220i	37
ERTD10/16-3	395230i	37
ERTD10/16-4	395240i	37
ERTD10/16-5	395250i	37
ERF2 BEIGE	351100i	32
ERF2LD110AC	351510i	32
ERF2LD110DC	351520i	32
ERF2LD220AC	351610i	32
ERF2LD220DC	351620i	32
ERF2LD24AC	351210i	32
ERF2LD24DC	351220i	32
ERF2LD48AC	351310i	32
ERF2LD48DC	351320i	32

Part No	Code	Page
ERF3 BEIGE	354100i	33
ERF3LD110AC	354510i	33
ERF3LD110DC	354520i	33
ERF3LD220AC	354610i	33
ERF3LD220DC	354620i	33
ERF3LD24AC	354210i	33
ERF3LD24DC	354220i	33
ERF3LD48AC	354310i	33
ERF3LD48DC	354320i	33
ERF3M BEIGE	355100i	33
ERF3MLD110AC	355510i	33
ERF3MLD110DC	355520i	33
ERF3MLD220AC	355610i	33
ERF3MLD220DC	355620i	33
ERF3MLD24AC	355210i	33
ERF3MLD24DC	355220i	33
ERF3MLD48AC	355310i	33
ERF3MLD48DC	355320i	33
ERF4LD	251---	34
ERPE2.5-T15	334420i	15
ERPE4-T15	334430i	15
ERP16/35	334160i	19
ERPE2.5/4	334120i	19
ERPE6/10	334140i	19
ERT2E BEIGE	324200i	27
ERT3 BEIGE	324100i	26
ERT3E BEIGE	324300i	27
ERT3S	324400i	28
ERTD2 BEIGE	360110i	31
ERTD3 BEIGE	362000i	31
ERTD3M BEIGE	363000i	31
ERTD4 BEIGE	353100i	31
ERWTO BEIGE	380500i	36
ERWT1 BEIGE	380501i	36
ERWT2 BEIGE	380502i	36
ES3	495030i	16
ES4	495050i	38
GM2	496250i	16
GM BEIGE	496110i	16
IC150	466119i	21
IC240	466129i	21
IC95	466109i	20
MT10/5	505910i	60
MT10/6	505915i	60
MT10/6.5	505920i	60
MT10/6.5-1-10	505201i	60
MT10/6.5-11-20	505202i	60
MT10/6.5-21-30	505203i	60
MT10/6.5-31-40	505204i	60
MT10/6.5-41-50	505205i	60
MT10/6.5-51-60	505206i	60
MT10/6.5-61-70	505207i	60
MT10/6.5-71-80	505208i	60
MT10/6.5-81-90	505209i	60
MT10/6.5-91-100	505910i	60
MT5	505850i	60
MT5-	505096i	60
MT5+	505095i	60
MT5-0	505000i	60
MT5-1	505001i	60
MT5-10	505010i	60
MT5-10-100	505030i	60
MT5-101-150	505042i	60
MT5-1-10	505050i	60

Part No	Code	Page
MT5-11-20	505021i	60
MT5-1-50	505040i	60
MT5-151-200	505043i	60
MT5-2	505002i	60
MT5-201-250	505044i	60
MT5-21-30	505022i	60
MT5-250-300	505045i	60
MT5-3	505003i	60
MT5-301-350	505046i	60
MT5-31-40	505023i	60
MT5-350-400	505047i	60
MT5-4	505004i	60
MT5-401-450	505048i	60
MT5-41-50	505024i	60
MT5-451-500	505049i	60
MT5-5	505005i	60
MT5-501-550	505050i	60
MT5-51-100	505041i	60
MT5-551-600	505051i	60
MT5-6	505006i	60
MT5-601-650	505052i	60
MT5-651-700	505053i	60
MT5-7	505007i	60
MT5-701-750	505054i	60
MT5-701-800	505055i	60
MT5-8	505008i	60
MT5-801-850	505056i	60
MT5-851-900	505057i	60
MT5-9	505009i	60
MT5-901-950	505058i	60
MT5-951-999	505059i	60
MT5-A	505060i	60
MT5-B	505061i	60
MT5-C	505062i	60
MT5-D	505063i	60
MT5-E	505064i	60
MT5-F	505065i	60
MT5-G	505066i	60
MT5-H	505067i	60
MT5-I	505068i	60
MT5-J	505069i	60
MT5-K	505070i	60
MT5-L	505071i	60
MT5-L-1	505090i	60
MT5-L2	505091i	60
MT5-L3	505092i	60
MT5-M	505072i	60
MT5-N	505073i	60
MT5-O	505074i	60
MT5-P	505075i	60
MT5-Q	505076i	60
MT5-R	505077i	60
MT5-S	505078i	60
MT5-T	505079i	60
MT5-U	505080i	60
MT5-V	505081i	60
MT5-W	505082i	60
MT5-X	505083i	60
MT5-Y	505084i	60
MT5-Z	505085i	60
PBB3	525350i	33
PM2.5		56
PM4		57
PM10		57
PMC2.5/4		56
PMC10		57

Part No	Code	Page
PME2.5		56
PME4		57
PME10		57
SC10	306250i	39
SC2.5	306220i	38
SC4	306230i	39
SC6	306240i	39
SCD2.5	316100i	42
SCD2.5C	326100i	42
SCD2.5CS	326200i	43
SCD2.5CD	326210i	43
SCD2.5CLD	326--0i	43
SCD2.5D	316220i	47
SCD2.5E	326050i	42
SCD2.5LD	316--0i	47
SCD2.5PE	336100i	43
SCD2.5V	316120i	47
SCD4	318100i	48
SCD4D	318220i	49
SCD4LD		49
SCD4V	318120i	49
SCPE10	336250i	45
SCPE2.5	336220i	44
SCPE4	336230i	45
SCPE6	336240i	45
SCS2.5	364010i	40
SCS2.5E	364050i	41
SCS2.5EL	364---	41
SCS2.5IP		40
SCS2.5L	364---	41
SCS2.5N	364011i	41
SCTD4	353200i	51
SCT3	324500i	52
SCT2E	324800i	53
SCT3S	324700i	54
SCT3SLD	324710i	55
SCT3SLD	334720i	55
SP1 BEIGE	467910i	16
SP2.5-10	462120i	16
TS1	420020i	58
TS2/10	421100i	58
TS2/2	421020i	58
WL1 YELLOW	498133i	16
WL2 YELLOW	498143i	16
WL3	49143i	17

Coming Soon



 *The World's Finest*

Push-Fit Terminals

Range Features

This unique product will be an excellent addition to our already comprehensive range of DIN terminals, which will provide the engineer with a quick and easy installation.

The terminal's unique push-in technology allows the user to connect their ferrule terminated cabling by simply pushing it into the terminal's connection.

The terminal also allows for a cross connection bar to be 'push-in' connectable for faster installation.

Higher retaining force makes this product superior to the spring clamp.

Caractéristiques de la gamme

Ce produit unique viendra compléter notre large gamme de blocs de jonction rail Din, et réduira considérablement le temps de câblage.

La technologie exclusive "push-in" permet de connecter le câble électrique, terminé par une fêrulle, rien qu'en le poussant dans le logement prévu dans le bloc de jonction.

Ce nouveau bloc de jonction permet également l'utilisation de Barres Communes a pousser afin de réduire le temps de câblage.

Avec une force de maintien plus élevée, ce produit est supérieur au bloc de jonction a ressort.

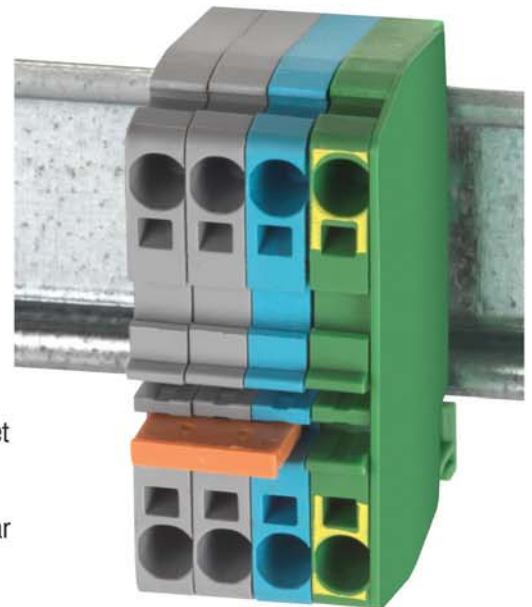

Step 1 - Push



Step 2 - Lock

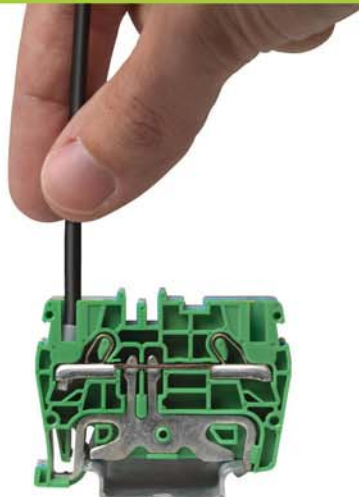

Step 3 - Release

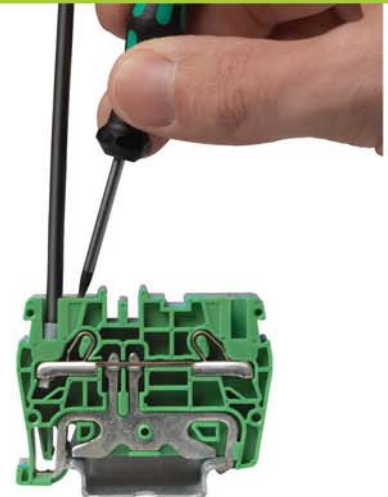



 *The World's Finest*

IMO Precision Controls Limited
1000 North Circular Road
Staples Corner
London NW2 7JP
United Kingdom

Tel: +44 (0)20 8452 6444
Fax: +44 (0)20 8450 2274
Email: imo@imopc.com
Web: www.imopc.com

IMO Automazione
Viale A. Volta 127/a
50131 Firenze
Italia

Tel: +39 800 783281
Fax: +39 800 783282
Email: info@imopc.it
Web: www.imopc.it

IMO Jeambrun Automation SAS
Centre D'Affaires Rocroy
30, Rue de Rocroy
94100 Saint-Maur-Des-Fosses
France

Tel: +8000 452 6444
Fax: +8000 452 6445
Email: info@imopc.fr
Web: www.imopc.fr

IMO Canada
Unit 10, 1 Whitmore Road
Woodbridge
Ontario L4L 8G4
Canada

Tel: +1 905 265 9844
Fax: +1 905 265 1749
Email: imocanada@imopc.com
Web: www.imopc.com